

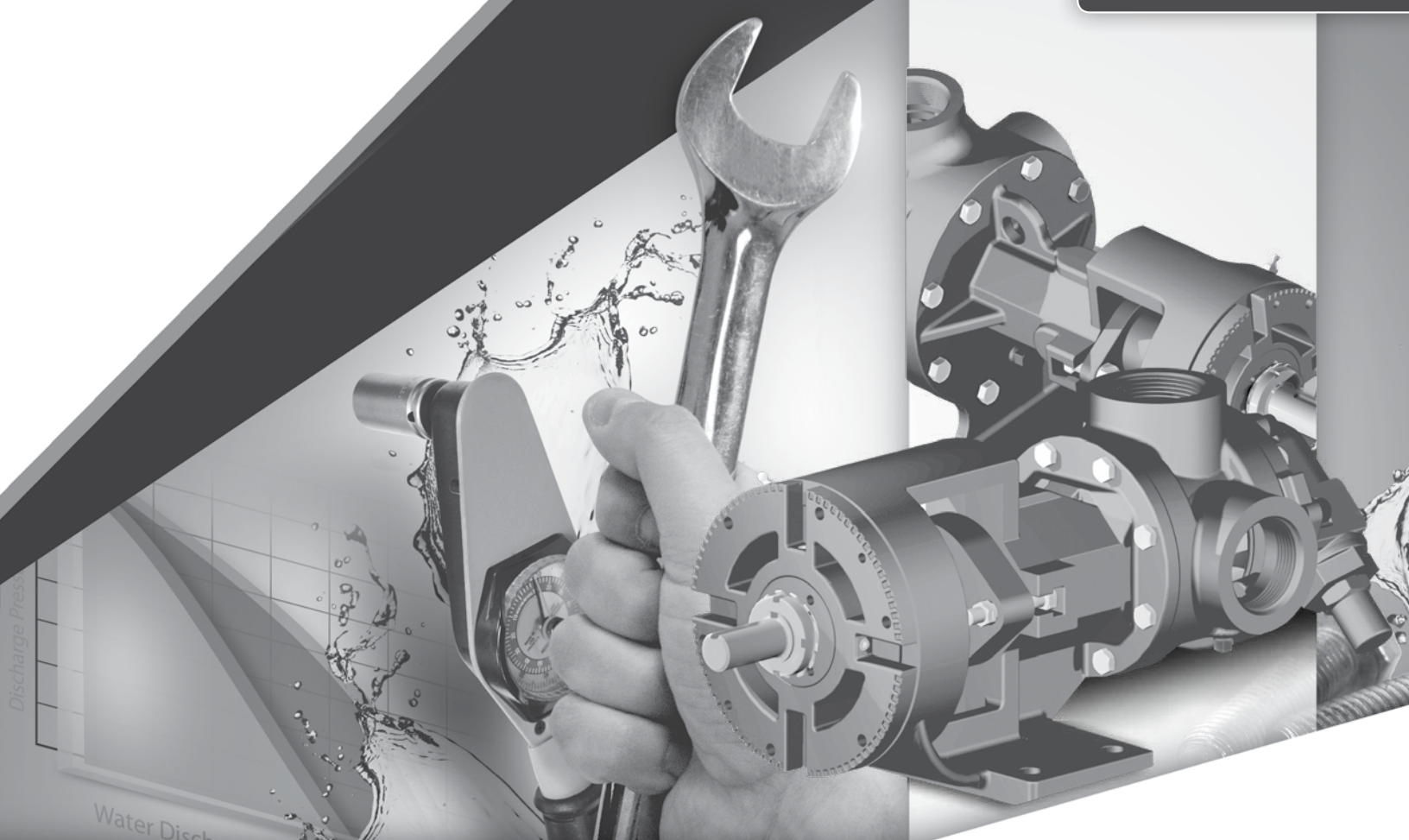

# IOM

Installation  
Operation  
Maintenance  
Manual

**G Series**  
Sealed Internal  
Gear Pumps

























Where Innovation Flows

[envirogearpump.com](http://envirogearpump.com)



<b>SECTION 1</b>	<b>CAUTIONS—READ FIRST!</b> .....	1
<b>SECTION 2</b>	<b>PUMP DESIGNATION SYSTEM</b> .....	2
<b>SECTION 3</b>	<b>HOW IT WORKS—INTERNAL GEAR TECHNOLOGY</b> .....	4
<b>SECTION 4</b>	<b>SUGGESTED INSTALLATION &amp; OPERATION</b> .....	5
<b>SECTION 5</b>	<b>MAINTENANCE</b> .....	10
<b>SECTION 6</b>	<b>DISASSEMBLY</b> .....	12
<b>SECTION 7</b>	<b>REASSEMBLY</b> .....	13
<b>SECTION 8</b>	<b>EXPLODED VIEW AND PARTS LISTING</b>	
	G1-2/4 .....	18
	G1-24/32 .....	22
	G1-55/69 .....	26
	G1-82 .....	30
	G1-133 .....	35
	G1-222 .....	38
<b>SECTION 9</b>	<b>TROUBLESHOOTING</b> .....	42

-  **CAUTION:** Only personnel who are familiar with the operation and repair of mechanical products should perform the necessary maintenance. You must familiarize yourself with the entire contents of this manual prior to operating and/or performing any maintenance.
-  **CAUTION:** When selecting a G Series pump for an application, you must first ensure that the pump components are compatible with the process media.
-  **CAUTION:** Prior to startup, review and understand end-clearance adjustments. Following these guidelines will ensure proper end-clearance adjustment avoiding interference between the gears and head. Interference may cause heat generation and premature wear.
-  **CAUTION:** Do not operate this pump in excess of its rated capacity, pressure, speed and temperature.
-  **CAUTION:** Before any maintenance and repair is attempted, disconnect the drive.
-  **CAUTION:** Before any maintenance or repair is attempted, bleed all pressure from the pump through the suction or discharge lines.
-  **CAUTION:** Do not remove any pressure-containing components during pump operation.
-  **CAUTION:** All G Series pumps contain residual hydraulic oil from the factory production test. Hypar-FG 15 food-grade oil is the standard production test fluid, but any certified performance testing may be done on a non-food grade oil, such as Unilube 32 (ISO 32) or Unilube 100 (ISO 100). Determine if this is compatible with the fluid you are pumping. If the fluid is incompatible, then the pump must be fully flushed prior to use.
-  **CAUTION:** When pumping fluids at elevated temperatures, care should be taken to gradually increase temperature. Rapid temperature increase can damage internal components.
-  **CAUTION:** Ensure that the pump has cooled to a safe temperature before any maintenance or repair is attempted.
-  **CAUTION:** When pumping fluids at elevated temperatures the piping may expand, resulting in excessive stress on the pump. This can cause pump failure. Care must be taken when considering pipe design to avoid damage from thermal expansion.
-  **CAUTION:** Do not run the pump dry. This can cause damage to internal components and generate heat, creating a hazardous condition for volatile fluids.
-  **CAUTION:** Prevention of static sparking – If static sparking occurs, fire or explosion could result. Pump, valves and containers must be grounded to a proper grounding point when handling flammable fluids and whenever discharge of static electricity is a hazard.
-  **CAUTION:** The packing in a packed pump is designed to leak. Therefore, when pumping hazardous liquids, a mechanical seal is recommended to minimize any potential source of leakage that could result in a hazardous condition.
-  **CAUTION:** Do not adjust packing while pump is in operation.
-  **CAUTION:** All inlet and discharge plumbing should be clean and free from foreign material prior to startup of pump.
-  **CAUTION:** Keep hands and fingers away from any pump opening while the pump is connected to the drive.
-  **CAUTION:** When connecting to an electric motor, follow all safety recommendations provided by the motor manufacturer.
-  **WARNING:** In any positive-displacement pump system, a reliable pressure-protection device must be used in the discharge piping to avoid a dangerous pressure increase, which could cause the pump or any component in the discharge piping to burst and can lead to serious injury. A pump-mounted integral relief valve is not intended to be used in this manner.
-  **CAUTION:** Never remove safety guards from shafts, couplings, V-belts or pulleys during operation. Doing so could result in injury.
-  **CAUTION:** When pumping high-temperature fluids, avoid contact with the pump. Serious injury could occur.
-  **CAUTION:** Do not wear loose or dangling clothing or jewelry near the equipment. These items could become caught in the equipment and cause injury.
-  **CAUTION:** Before any maintenance or repair is attempted, ensure that the pump has been thoroughly flushed of any hazardous fluids. Review the Material Safety Data Sheet (MSDS) applicable to the fluid for proper handling.

**GEAR PUMP**

**LEGEND**

**G1-XXXXXX/XXXXXX/XXXXXX/XX/XXX**

MODEL

EXTERNALS

INTERNALS

CLEARANCE

PORTS

ORIENTATION

BUSHINGS

SEAL TYPE

SEAL MATERIAL

SEAL FACES

RELIEF VALVE

SPECIALTY CODE  
(if applicable)

**MATERIAL CODES**

**MODELS**

- G1-2 = 2 in<sup>3</sup>/rev
- G1-4 = 4 in<sup>3</sup>/rev
- G1-24 = 24 in<sup>3</sup>/rev
- G1-32 = 32 in<sup>3</sup>/rev
- G1-55 = 55 in<sup>3</sup>/rev
- G1-69 = 69 in<sup>3</sup>/rev
- G1-82 = 82 in<sup>3</sup>/rev
- G1-133 = 133 in<sup>3</sup>/rev
- G1-222 = 222 in<sup>3</sup>/rev

**MATERIAL (EXTERNAL)**

- C = CARBON STEEL
- S = STAINLESS STEEL
- W = CAST IRON

**MATERIAL (INTERNALS)**

- C = STEEL
- D = DUCTILE IRON
- N = NITRONIC 60
- S = STAINLESS STEEL
- W = CAST IRON

**CLEARANCES (G1-2/4):  
IRON/STEEL ROTOR**

- A = [ $<540$  cSt,  $<107^{\circ}\text{C}$  ( $<225^{\circ}\text{F}$ )
- B = [ $<540$  cSt,  $108-232^{\circ}\text{C}$  ( $226-450^{\circ}\text{F}$ )
- C = [ $<540$  cSt,  $233-301^{\circ}\text{C}$  ( $451-575^{\circ}\text{F}$ )
- D = [ $540-5,400$  cSt,  $302-343^{\circ}\text{C}$  ( $576-650^{\circ}\text{F}$ )
- E = [ $5,400-431,000$  cSt,  $302-343^{\circ}\text{C}$  ( $576-650^{\circ}\text{F}$ )

**CLEARANCES (G1-2/4):  
STAINLESS STEEL ROTOR**

- A = [ $<540$  cSt,  $<107^{\circ}\text{C}$  ( $<225^{\circ}\text{F}$ )
- B = [ $<540$  cSt,  $108-149^{\circ}\text{C}$  ( $226-300^{\circ}\text{F}$ )
- C = [ $540-5,400$  cSt,  $150-260^{\circ}\text{C}$  ( $301-500^{\circ}\text{F}$ )
- D = [ $5,400-431,000$  cSt,  $150-260^{\circ}\text{C}$  ( $301-500^{\circ}\text{F}$ )

**CLEARANCES (G1-24/32):  
IRON ROTOR**

- A = [ $<160$  cSt,  $<107^{\circ}\text{C}$  ( $<225^{\circ}\text{F}$ )
- B = [ $<160$  cSt,  $108-149^{\circ}\text{C}$  ( $226-300^{\circ}\text{F}$ )
- C = [ $160-1,600$  cSt,  $150-232^{\circ}\text{C}$  ( $301-450^{\circ}\text{F}$ )
- D = [ $1,600-16,000$  cSt,  $233-343^{\circ}\text{C}$  ( $451-650^{\circ}\text{F}$ )
- E = [ $16,000-431,000$  cSt,  $233-343^{\circ}\text{C}$  ( $451-650^{\circ}\text{F}$ )

**CLEARANCES (G1-24/32):  
STEEL ROTOR:**

- A = [ $<160$  cSt,  $<107^{\circ}\text{C}$  ( $<225^{\circ}\text{F}$ )
- B = [ $<160$  cSt,  $108-232^{\circ}\text{C}$  ( $226-450^{\circ}\text{F}$ )
- C = [ $160-1,600$  cSt,  $233-343^{\circ}\text{C}$  ( $451-650^{\circ}\text{F}$ )
- D = [ $1,600-16,000$  cSt,  $233-343^{\circ}\text{C}$  ( $451-650^{\circ}\text{F}$ )
- E = [ $16,000-431,000$  cSt,  $233-343^{\circ}\text{C}$  ( $451-650^{\circ}\text{F}$ )

**CLEARANCES (G1-24/32):  
STAINLESS STEEL ROTOR**

- A = [ $<1600$  cSt,  $<107^{\circ}\text{C}$  ( $<225^{\circ}\text{F}$ )
- B = [ $<1600$  cSt,  $108-177^{\circ}\text{C}$  ( $226-350^{\circ}\text{F}$ )
- C = [ $1,600-16,000$  cSt,  $177-260^{\circ}\text{C}$  ( $351-500^{\circ}\text{F}$ )
- D = [ $16,000-431,000$  cSt,  $177-260^{\circ}\text{C}$  ( $351-500^{\circ}\text{F}$ )

**CLEARANCES (G1-55/69): IRON ROTOR**

- A = [ $<160$  cSt,  $<107^{\circ}\text{C}$  ( $<225^{\circ}\text{F}$ )
- B = [ $<160$  cSt,  $108-149^{\circ}\text{C}$  ( $226-300^{\circ}\text{F}$ )
- C = [ $160-1,600$  cSt,  $150-232^{\circ}\text{C}$  ( $301-450^{\circ}\text{F}$ )
- D = [ $1,600-16,000$  cSt,  $233-302^{\circ}\text{C}$  ( $451-575^{\circ}\text{F}$ )
- E = [ $1,600-16,000$  cSt,  $303-343^{\circ}\text{C}$  ( $576-650^{\circ}\text{F}$ )
- F = [ $16,000-431,000$  cSt,  $303-343^{\circ}\text{C}$  ( $576-650^{\circ}\text{F}$ )

**CLEARANCES (G1-55/69) STEEL ROTOR**

- A = [ $<160$  cSt,  $<107^{\circ}\text{C}$  ( $<225^{\circ}\text{F}$ )
- B = [ $160-1,600$  cSt,  $108-232^{\circ}\text{C}$  ( $226-450^{\circ}\text{F}$ )
- C = [ $1,600-16,000$  cSt,  $233-301^{\circ}\text{C}$  ( $451-575^{\circ}\text{F}$ )
- D = [ $1,600-16,000$  cSt,  $302-343^{\circ}\text{C}$  ( $576-650^{\circ}\text{F}$ )
- E = [ $16,000-431,000$  cSt,  $302-343^{\circ}\text{C}$  ( $576-650^{\circ}\text{F}$ )

**CLEARANCES (G1-55/69):  
STAINLESS STEEL ROTOR**

- A = [ $<1,600$  cSt,  $<107^{\circ}\text{C}$  ( $<225^{\circ}\text{F}$ )
- B = [ $1,600-16,000$  cSt,  $108-177^{\circ}\text{C}$  ( $226-350^{\circ}\text{F}$ )
- C = [ $1,600-16,000$  cSt,  $177-260^{\circ}\text{C}$  ( $351-500^{\circ}\text{F}$ )
- D = [ $16,000-431,000$  cSt,  $177-260^{\circ}\text{C}$  ( $351-500^{\circ}\text{F}$ )

**CLEARANCES (G1-82): IRON/STEEL ROTOR**

- A = [ $<160$  cSt,  $<107^{\circ}\text{C}$  ( $<225^{\circ}\text{F}$ )
- B = [ $160-1,600$  cSt,  $108-232^{\circ}\text{C}$  ( $226-450^{\circ}\text{F}$ )
- C = [ $1,600-16,000$  cSt,  $233-301^{\circ}\text{C}$  ( $451-575^{\circ}\text{F}$ )
- D = [ $1,600-16,000$  cSt,  $302-343^{\circ}\text{C}$  ( $576-650^{\circ}\text{F}$ )
- E = [ $16,000-431,000$  cSt,  $302-343^{\circ}\text{C}$  ( $576-650^{\circ}\text{F}$ )

**CLEARANCES (G1-82):  
STAINLESS STEEL ROTOR**

- A = [ $<160$  cSt,  $<107^{\circ}\text{C}$  ( $<225^{\circ}\text{F}$ )
- B = [ $160-1,600$  cSt,  $108-163^{\circ}\text{C}$  ( $226-325^{\circ}\text{F}$ )
- C = [ $1,600-16,000$  cSt,  $163-260^{\circ}\text{C}$  ( $326-500^{\circ}\text{F}$ )
- D = [ $16,000-431,000$  cSt,  $163-260^{\circ}\text{C}$  ( $326-500^{\circ}\text{F}$ )

**CLEARANCES (G1-133/222):  
IRON/STEEL ROTOR**

- A = [ $<160$  cSt,  $<107^{\circ}\text{C}$  ( $<225^{\circ}\text{F}$ )
- B = [ $160-1,600$  cSt,  $108-232^{\circ}\text{C}$  ( $226-450^{\circ}\text{F}$ )
- C = [ $1,600-16,000$  cSt,  $233-343^{\circ}\text{C}$  ( $451-650^{\circ}\text{F}$ )
- D = [ $16,000-431,000$  cSt,  $233-343^{\circ}\text{C}$  ( $451-650^{\circ}\text{F}$ )

**CLEARANCES (G1-133/222):  
STAINLESS STEEL ROTOR**

- A = [ $<1,600$  cSt,  $<135^{\circ}\text{C}$  ( $<275^{\circ}\text{F}$ )
- B = [ $1,600-16,000$  cSt,  $136-260^{\circ}\text{C}$  ( $276-500^{\circ}\text{F}$ )
- C = [ $16,000-431,000$  cSt,  $136-260^{\circ}\text{C}$  ( $276-500^{\circ}\text{F}$ )

**PORTS**

- 1.5A = 1.5 in ANSI
- 1.5N = 1.5 in NPT
- 2A = 2 in ANSI
- 2N = 2 in NPT
- 2.5A = 2.5 in ANSI
- 3A = 3 in ANSI
- 4A = 4 in ANSI
- 6A = 6 in ANSI

**ORIENTATION (when looking at the shaft)**

- RT = Right Port, Top Port
- LT = Left Port, Top Port
- RB = Right Port, Bottom Port
- LB = Left Port, Bottom Port
- RL = Right Port, Left Port
- LR = Left Port, Right Port

**BUSHING**

- C = Carbon-graphite bushings
- B = Bronze bushings
- T = Tungsten-carbide bushings

**SEAL TYPE/MATERIAL**

- 1B = Type 1 Mechanical Seal (Buna-N)
- 1V = Type 1 Mechanical Seal (Viton)
- 9T = Type 9 Mechanical Seal (PTFE)
- PG = Packing (PTFE-GRAPHITE)

**SEAL FACES**

- CN = CARBON - NI-RESIST
- NA = NOT APPLICABLE (PACKING)
- NS = NO SEAL

**RELIEF VALVE (G1-2/4): CAST IRON / CARBON STEEL**

- N = NO RELIEF VALVE
- 07 = 2.1 to 5.2 bar (30 to 75 psi)
- 12 = 5.2 to 8.6 bar (76 to 125 psi)
- 20 = 8.7 to 13.8 bar (126 to 200 psi)

**RELIEF VALVE (G1-2/4):  
STAINLESS STEEL**

- N = NO RELIEF VALVE
- 07 = 2.1 to 5.2 bar (30 to 75 psi)
- 12 = 5.2 to 8.6 bar (76 to 125 psi)
- 15 = 8.7 to 10.34 bar (126 to 150 psi)

**RELIEF VALVE (G1-24/32):  
CAST IRON / CARBON STEEL**

- N = NO RELIEF VALVE
- 05 = 1.0 to 3.5 bar (15 to 50 psi)
- 08 = 3.5 to 5.5 bar (51 to 80 psi)
- 15 = 5.6 to 10.3 bar (81 to 150 psi)
- 20 = 10.4 to 13.8 bar (151 to 200 psi)

**RELIEF VALVE (G1-24/32):  
STAINLESS STEEL**

- N = NO RELIEF VALVE
- 05 = 1.0 to 3.5 bar (15 to 50 psi)
- 08 = 3.5 to 5.5 bar (51 to 80 psi)
- 15 = 5.6 to 10.3 bar (81 to 150 psi)

**RELIEF VALVE (G1-55/69/82):  
CAST IRON / CARBON STEEL**

- N = NO RELIEF VALVE
- 06 = 1.4 to 4.1 bar (20 to 60 psi)
- 09 = 4.2 to 6.2 bar (61 to 90 psi)
- 16 = 6.3 to 11.1 bar (91 to 160 psi)
- 20 = 11.1 to 13.8 bar (161 to 200 psi)

**RELIEF VALVE (G1-55/69/82):  
STAINLESS STEEL**

- N = NO RELIEF VALVE
- 06 = 1.4 to 4.1 bar (20 to 60 psi)
- 09 = 4.2 to 6.2 bar (61 to 90 psi)
- 15 = 6.3 to 10.3 bar (91 to 150 psi)

**RELIEF VALVE (G1-133/222)  
CAST IRON**

- N = NO RELIEF VALVE
- 05 = 1.4 to 3.5 bar (20 to 50 psi)
- 08 = 3.5 to 5.5 bar (51 to 80 psi)
- 13 = 5.6 to 9.0 bar (81 to 130 psi)
- 20 = 9.0 to 13.8 bar (131 to 200 psi)

**RELIEF VALVE (G1-133/222)  
STAINLESS STEEL**

- N = NO RELIEF VALVE
- 05 = 1.4 to 3.5 bar (20 to 50 psi)
- 08 = 3.5 to 5.5 bar (51 to 80 psi)
- 13 = 5.6 to 9.0 bar (81 to 130 psi)
- 15 = 9.0 to 10.3 bar (131 to 150 psi)

# PUMP NOMINAL RATINGS



Nominal Pump Rating		Max. Discharge Pressure		Max. Temperature	Nominal Pump Rating		Max. Discharge Pressure		Max. Temperature	Nominal Pump Rating		Max. Discharge Pressure		Max. Temperature
CAST IRON					CARBON STEEL					STAINLESS STEEL				
Model	RPM	GPM (m <sup>3</sup> /h)	PSIG (bar)	Fahrenheit (Celsius)	RPM	GPM (m <sup>3</sup> /h)	PSIG (bar)	Fahrenheit (Celsius)	RPM	GPM (m <sup>3</sup> /h)	PSIG (bar)	Fahrenheit (Celsius)		
G1-2	1,750	15 (3.4)	200 (13.8) >20 cSt	650° (343°)	1,750	15 (3.4)	200 (13.8) >20 cSt	650° (343°)	1,150	10 (2.3)	150 (10.3) >550 cSt	500° (260°)		
G1-4	1,750	30 (6.8)	200 (13.8) >20 cSt	650° (343°)	1,750	30 (6.8)	200 (13.8) >20 cSt	650° (343°)	1,150	20 (4.5)	150 (10.3) >550 cSt	500° (260°)		
G1-24	780	75 (17.0)	200 (13.8) >20 cSt	650° (343°)	780	75 (17.0)	200 (13.8) >20 cSt	650° (343°)	520	50 (11.4)	150 (10.3) >550 cSt	500° (260°)		
G1-32	780	100 (22.7)	200 (13.8) >20 cSt	650° (343°)	780	100 (22.7)	200 (13.8) >20 cSt	650° (343°)	520	65 (14.8)	150 (10.3) >550 cSt	500° (260°)		
G1-55	640	135 (30.7)	200 (13.8) >20 cSt	650° (343°)	640	135 (30.7)	200 (13.8) >20 cSt	650° (343°)	420	90 (20.4)	150 (10.3) >550 cSt	500° (260°)		
G1-69	520	140 (31.8)	200 (13.8) >20 cSt	650° (343°)	520	140 (31.8)	200 (13.8) >20 cSt	650° (343°)	420	110 (25.0)	150 (10.3) >550 cSt	500° (260°)		
G1-82	640	200 (45.4)	200 (13.8) >165 cSt	500° (260°)	640	200 (45.4)	200 (13.8) >165 cSt	500° (260°)	520	160 (36.3)	125 (8.6) >550 cSt	500° (260°)		
G1-133	520	300 (68.1)	200 (13.8) >165 cSt	500° (260°)	520	300 (68.1)	200 (13.8) >165 cSt	500° (260°)	350	200 (45.4)	125 (8.6) >25 cSt	500° (260°)		
G1-222	520	500 (113.6)	200 (13.8) >165 cSt	500° (260°)	520	500 (113.6)	200 (13.8) >165 cSt	500° (260°)	350	320 (72.7)	125 (8.6) >25 cSt	500° (260°)		

(1) Maximum pressure listed reflects maximum differential pressure and maximum allowable working pressure.  
 (2) Values listed in table are nominal and for reference only. To ensure proper pump selection, always refer to EnviroGear Select.

The G SERIES GEAR PUMP is a rotating, positive displacement pump. These drawings show the flow pattern through the pump upon its initial rotation. It is assumed that the pump has no fluid in it prior to its initial rotation.

**1** The shaded area indicates the liquid as it is drawn into the liquid inlet port of the pump. As the rotor turns, atmospheric pressure forces the liquid between the rotor teeth and idler teeth. The two arrows indicate the rotational direction of the pump.

**2** As the rotor continues to turn, the liquid is forced through the crescent-shaped area of the wetted path. The crescent-shaped area divides the liquid and acts as a barrier between the inlet and discharge ports.

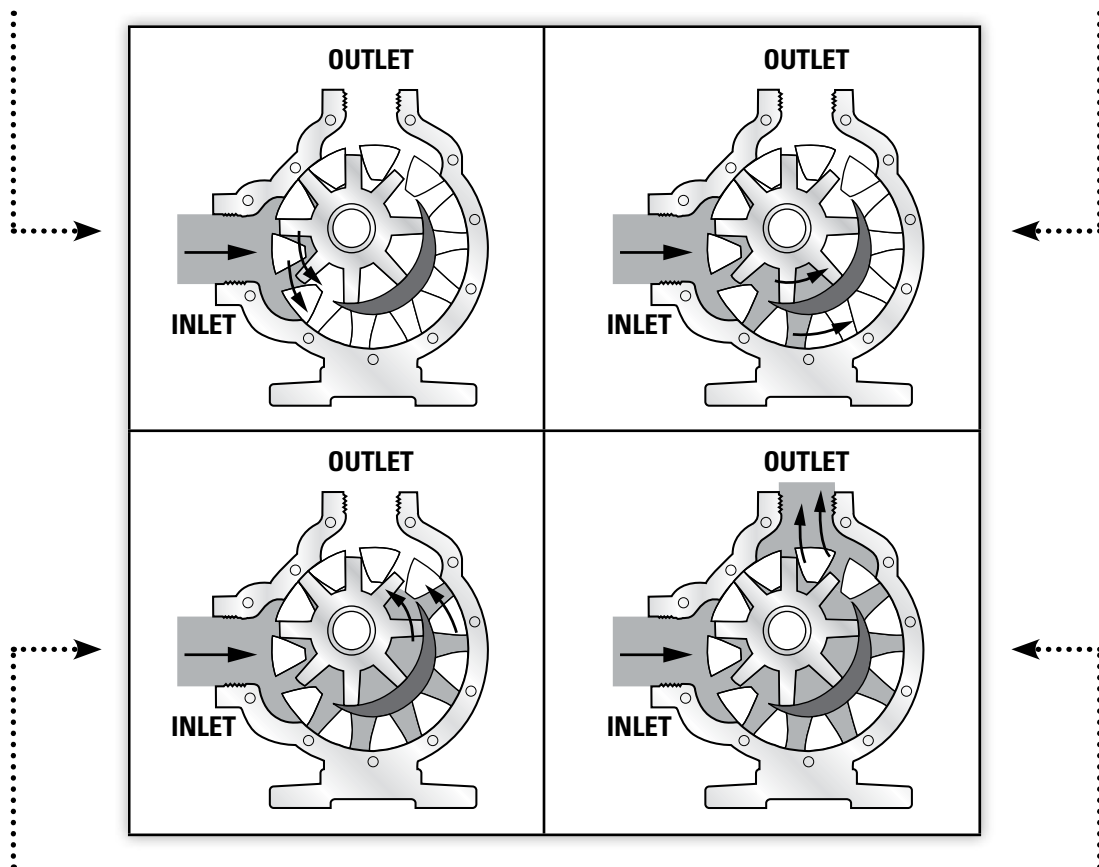

**3** As the rotor continues to turn, the liquid is forced past the crescent-shaped area and moves toward the discharge port.

**4** As the rotor completes one complete rotation, the rotor and idler teeth interlock, forcing the liquid through the discharge of the pump. The pump may take several rotations to completely prime depending on the conditions of the application.

G Series gear pumps are designed to meet the performance requirements of even the most demanding pumping applications. They have been designed and manufactured to the highest standards and are available in a number of different sizes to meet your pumping needs. Refer to the performance section of this manual for an in-depth analysis of the performance characteristics of your pump.

## INSTALLATION

Months of careful planning, study and selection efforts can result in unsatisfactory pump performance if installation details are left to chance.

Premature failure and long-term dissatisfaction can be avoided if reasonable care is exercised throughout the installation process.

## LOCATION

Noise, safety and other logistical factors usually dictate where equipment will be situated on the production floor. Multiple installations with conflicting requirements can result in congestion of utility areas, leaving few choices for additional pumps.

Within the framework of these and other existing conditions, every pump should be located in such a way that key factors are balanced against each other to maximum advantage.

## ACCESS

The location of the pumping unit should be accessible. If it's easy to reach the pump for maintenance personnel will have an easier time carrying out routine inspections and adjustments. Should major repairs

become necessary, ease of access can play a key role in speeding the repair process and reducing total downtime.

## FOUNDATION

### BASEPLATES AND ANCHORS:

The preferred mounting for a baseplate is on a concrete pad with grouting. No matter how robust the design, there is always some flexibility in the baseplate itself. If there is insufficient support under the baseplate, it can distort causing alignment difficulties and normal vibrations can be amplified to unacceptable levels through resonance in the pump support and/or piping. A properly grouted baseplate will resist distortion and will provide sufficient mass to dampen any vibration.

**NOTE:** When pumps and motors are assembled on a baseplate at the factory, a preliminary alignment is done to ensure that the pump and motor can be aligned at its installation. This alignment is not to be considered as a final alignment. The factory alignment can, and does, change during shipment and when the pumping unit is installed. Actually, several alignments are necessary as will be described later.

Anchor (foundation) bolts are used to hold the baseplate to its support structure, whatever that may be. In the preferred case of mounting the pump unit on a concrete pad, the anchor bolts are set into the pad as indicated in the following illustration. When pouring the pad, it's helpful to have a wooden template attached to the foundation form to position the anchor bolts at their locations as indicated on the pump unit assembly drawing.

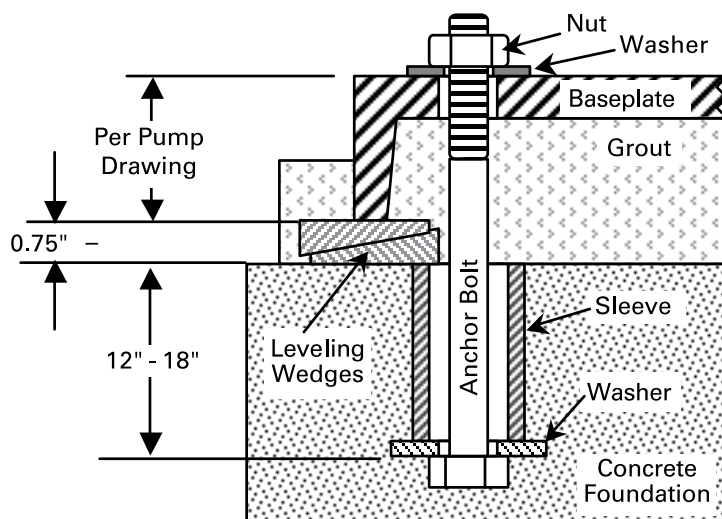

FIGURE A – TYPICAL ANCHOR BOLT (SLEEVE TYPE)

Anchor bolts are usually sized smaller than the anchor bolt hole size in the base. Calculate bolt length as indicated in the Figure A on the left.

The ID of the sleeve should be two bolt sizes larger than the anchor bolt.

Allow approx.  $\frac{3}{4}$ " -  $1\frac{1}{2}$ " space between the bottom edge of the baseplate and the foundation for grouting.

A "Sleeve" type anchor bolt is shown here. Alternatively, a "hook" or "J" type anchor bolt may be used.

Pack the space between the anchor bolt and sleeve to prevent concrete and/or grout from entering this area.

## BASE INSTALLATION AND GROUTING:

**NOTE:** Before the baseplate is installed, it is advisable to thoroughly clean the underside to enable the grouting to adhere to it. Do not use oil-based cleaners since grout will not bond to it.

Once the concrete pad has cured, the baseplate can be carefully lowered over the anchor bolts.

Place shims or tapered wedges under the baseplate at each of the anchor bolt positions to provide about 0.75" – 1.50" clearance between the base and the foundation. Adjust shims/wedges to level the baseplate. **Since there may be some flexibility in the baseplate, we must perform an initial alignment prior to grouting to ensure that a final alignment can be achieved. See section covering Alignment of Pump/Driver Shafts.** Potential problems here include bowing and/or twisting of the baseplate. If gross misalignment is observed, shims/wedges may have to be added under the mid-point of the base or the shims/wedges at the corners may have to be adjusted to eliminate any twist. If the driver feet are bolt-bound for horizontal alignment, it may be necessary to loosen the pump hold-down bolts and shift the pump and driver to attain horizontal alignment. When alignment has been achieved, lightly tighten the anchor bolts. The anchor bolts should not be fully tightened until the grout has set.

Grouting furnishes support for the pump unit baseplate providing rigidity, helping to dampen any vibration and serves to distribute the weight of the pump unit over the foundation. To be effective, grouting must completely fill all voids under the baseplate. For proper adhesion or bonding, all areas of the baseplate that will be in contact with the grout should be thoroughly cleaned. See note above. The grout must be non-shrinking. Follow the directions of the grout manufacturer for mixing. Proceed with grouting as follows:

**NOTE:** If the size of the equipment or the layout of the installation requires it, grouting can be done in two steps as long as the first step is allowed to cure completely before the second step is applied

1. Build a sturdy form on the foundation around the baseplate to contain the grout.
2. Soak the top of the concrete foundation pad thoroughly. Remove surface water before pouring.
3. Pour the grout through the hole(s) in the top and/or through the open ends of the channel steel baseplate, eliminating air bubbles by tapping, using a vibrator or pumping the grout into place. If necessary, drill vent holes into the top of the base to evacuate air.

4. Allow grout to set completely, usually a minimum of 48 hours.
5. Tighten foundation anchor bolts.
6. Recheck alignment to ensure that there have been no changes.
7. After the grout has dried thoroughly, apply an oil base paint to shield the grout from air and moisture.

## PIPING

Final determination of the pump site should not be made until the piping challenges of each possible location have been evaluated. The impact of current and future installations should be considered ahead of time to make sure that inadvertent restrictions are not created for any remaining sites.

The best choice possible will be a site involving the shortest and straightest hookup of suction and discharge piping. Unnecessary elbows, bends and fittings should be avoided. Pipe sizes should be selected to keep friction losses within practical limits.

All piping should be supported independently of the pump. In addition, the piping should be aligned to avoid placing stress on the pump fittings. To eliminate possible closing of the line when performing pump maintenance, a gate valve should be installed at the suction line.

G Series gear pumps are positive displacement pumps; as such, care must be used in protecting piping and components used in your system. Pumps equipped with an internal relief valve are designed to protect the pump only. A system relief valve should be installed along with the pump's internal relief valve.

When placing the pump, choose a location as close to the product source as possible. Care should be taken in your supply line to avoid cavitation due to viscosity and suction lift. **NOTE:** Some liquids may become thicker with temperature changes. Please refer to your supplier of product being pumped for information on viscosity changes due to temperature. Avoid air pockets on suction side of pump when designing piping layout. This will also reduce the possibility of cavitation. The weight of the piping should not be supported or absorbed by the pump. Suction and discharge piping should be supported by pipe hangers or another suitable means.

G SERIES GEAR PUMPS ARE NOT SUITED FOR PUMPING DIRTY, SOLID-LADEN LIQUIDS. A strainer should be used on the suction side of the pump. The strainer should consist of an adequate size mesh screen as to not cause excessive friction loss. It is suggested that a maintenance program is created to assure that the inlet strainer remains free of obstructions and blockage.

## ALIGNMENT OF PUMP/DRIVER SHAFTS

### WARNING!

**NOTE:** Driver power must be locked out before beginning any alignment procedure. Failure to lockout driver power may result in serious physical injury.

**NOTE:** Proper alignment is the responsibility of the installer and user of the equipment.

**NOTE:** Check alignment if process temperature changes, piping changes and/or pump service is performed.

Pump and driver shafts need to be aligned for both parallel and angular alignment. If there is a misalignment of the shafts, it will place a mechanical load on the pump and driver shaft/bearing assemblies as well as the coupling. This will result in vibration, noise and premature failures. Furthermore, due to the tight internal clearances of the G-Series pump, misalignment can cause deflection of the rotor into the stationary case or head. This can cause premature wear that will increase clearances, lead to decreased pump performance and potentially lead to pump failure. This is particularly important for stainless steel pumps.



FIGURE B – PARALLEL MISALIGNMENT

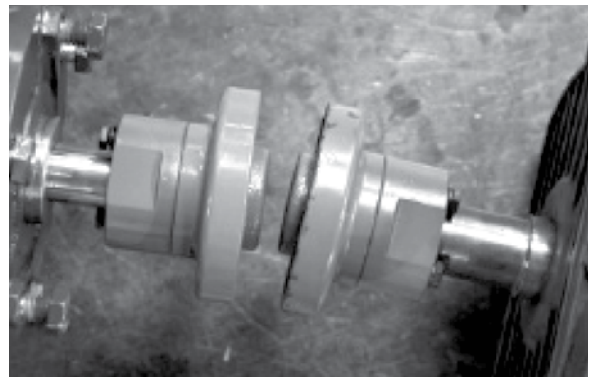

FIGURE C – ANGULAR MISALIGNMENT

To bring shafts into alignment, we first need to determine the amount and direction of both parallel and angular misalignments. We can then shim and reposition to correct.

It's preferable to shim ONLY under the driver feet since good contact between the pump foot and the base is necessary to resist any pump flange loading that might be imposed by the suction and/or discharge piping.

There are three methods commonly used to determine misalignment:

1. Straight edge and calipers or inside micrometer (least accurate)
2. Dial indicator (reasonably accurate)
3. Laser alignment equipment; see manufacturer's instructions for use

Since any misalignment will impose loads on the pump and driver shafts, the objective is to minimize any misalignment in order to protect the pump and driver and minimize any tendency for vibration. Suggested misalignment limits are:

MISALIGNMENT LIMITS		
PUMP FRAME GROUP	MAX. PARALLEL	MAX. ANGULAR
2/4, 24/32, 55/69, 82	0.005"	0.005"
133/222	0.010"	0.010"

For optimum performance and Mean Time Between Pump Maintenance (MTBPM), use alignment limits half of those shown above.

**NOTE:** In any case, disregard the coupling manufacturer's published misalignment limits, as these will impose unacceptable loads on the pump and motor shafts and bearings.

Alignment must be done at several different times:

1. Prior to grouting baseplate during installation
2. After grouting baseplate and tightening anchor bolts
3. After attaching suction and discharge piping prior to initial operation
4. Hot alignment after equipment temperatures have stabilized
5. After pump maintenance bearing housing is removed

Since the G-Series pump is foot-mounted, its shaft centerline will rise when handling pumpage at elevated temperatures. Similarly, the motor shaft centerline will rise as it reaches its operating temperature. Therefore, we will often purposely misalign shafts vertically during cold alignment to allow for thermal growth, thus bringing the shafts into alignment at operating temperature. This is shown in the "COLD SETTING OF PARALLEL VERTICAL ALIGNMENT" table.

The most simple alignment check is with a straight edge and calipers or inside micrometer. This method is the least accurate, but it will serve if a dial indicator or laser is not available.

### ALIGNMENT WITH STRAIGHT EDGE AND MICROMETER:

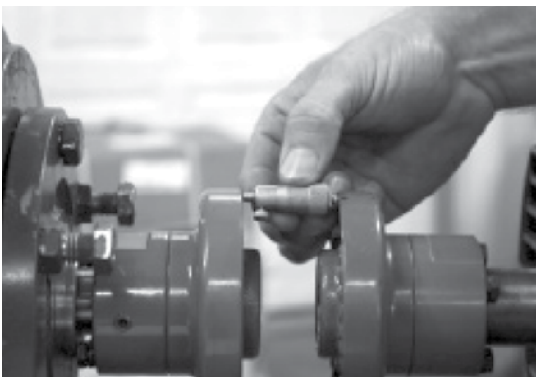

FIGURE D – ANGULAR ALIGNMENT

With coupling hubs stationary, use inside micrometer or calipers to measure the gap between the coupling hubs at 90° intervals. Adjust and/or shim equipment until the gap difference at all points around the hub(s) is less than the value shown in the "MISALIGNMENT LIMITS" table.

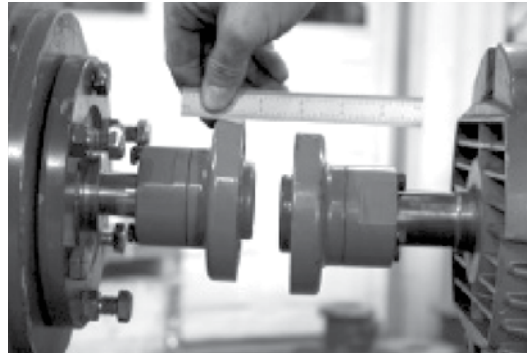

FIGURE E – PARALLEL MISALIGNMENT

With coupling hubs stationary, lay straight edge flat against rim of coupling hub to determine vertical and horizontal alignment offsets. Adjust and/or shim equipment until the straight edge lies flat against both hub rims, vertical and horizontal.

### DIAL INDICATOR METHOD

The dial indicator method is preferred for checking alignment.

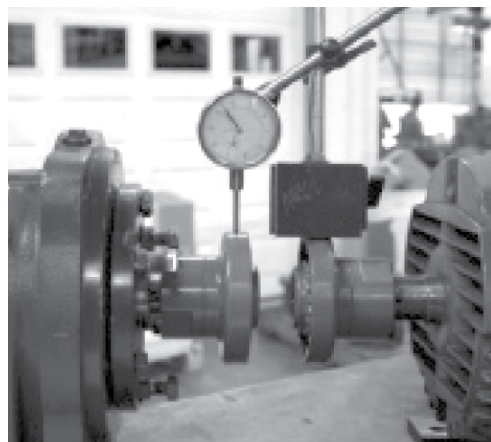

FIGURE F – DIAL INDICATOR SETUP

1. Scribe or mark index lines on both coupling hubs to indicate where the dial indicator point rests.
2. Set dial indicator to zero.
3. Slowly turn BOTH coupling hubs so that the index lines match or the indicator point is always on the mark.
4. Observe dial reading to determine required adjustments.

5. Acceptable parallel and angular alignment occurs when the total indicator reading (TIR) for a complete turn does not exceed the values shown in the “MISALIGNMENT LIMITS” table.

**LASER ALIGNMENT METHOD:**

The laser alignment method is preferred for checking alignment.

Laser alignment is usually the most accurate method. Follow the laser alignment equipment manufacturer’s instructions for this method.

As previously mentioned, pump and motor shafts need to be in alignment while they are at their intended operating temperature. When the shafts are aligned “cold” (at ambient temperature), we will intentionally position the motor shaft up or down in vertical parallel alignment to allow for thermal growth. Then, when the alignment is checked “hot” (at stable operating temperature), the shafts should be confirmed to be in alignment. Use the values in the following table as starting point for cold alignment settings. The actual cold alignment setting will be determined after the hot alignment is performed.

<b>COLD SETTING OF PARALLEL VERTICAL ALIGNMENT</b>	
<b>PUMPAGE TEMPERATURE</b>	<b>SET DRIVER SHAFT, INCHES</b>
10°C (50°F)	0.002" LOW
66°C (150°F)	0.001" HIGH
121°C (250°F)	0.005" HIGH
177°C (350°F)	0.009" HIGH
232°C (450°F)	0.013" HIGH
288°C (550°F)	0.017" HIGH
343°C (650°F)	0.021" HIGH

**PORT ORIENTATION AND SHAFT ROTATION:**

G Series pumps can be operated in either a clockwise or counterclockwise rotation. The shaft rotation determines which port is suction or discharge.

**PRESSURE RELIEF VALVES:**

- G Series pumps are positive displacement pumps, which means the system must have provisions for pressure relief protection, such as a relief valve mounted directly on the pump or inline with the system. Alternatively, the system can be installed with a torque-limiting device or a rupture disk.

- If the system requires the pump to operate in both directions, pressure relief protection is required on both sides of pump.
- When using an integral relief valve, the adjusting screw cap must always point towards the suction side of pump. If shaft rotation has to be reversed, simply remove the pressure relief valve and reinstall it in the proper configuration to avoid over-pressurization of the system.
- Pressure relief valves are not intended to control pump flow or regulate discharge pressure.
- The pump-mounted integral relief valve should never be relied upon for system protection.

**START UP**

- Check to ensure that the pressure/vacuum gauges are installed on inlet and discharge side of the pump.
- Check to ensure that installation and piping are correctly fastened and supported.
- Check to ensure that the pump and driver are properly aligned. Refer to “Alignment” section.
- Verify that the motor is wired correctly. Check to ensure that the thermal overload relays are properly sized and set for operation.
- With motor/driver locked out, check that the pump rotates by hand.
- Jog motor to validate correct rotation.
- Check to ensure that the coupling guard and all other safety-related devices and instrumentation are in place and in working order.
- Check to ensure that the pressure relief valve is installed correctly.
- Lubricate any grease fittings and/or bearings.
- Open suction, discharge and any auxiliary valves, such as in-line PRV loops, to ensure proper flow into and out of pump.
- Prime pumping chamber and seal chamber, if possible.
- If pump handles pumpage at temperature greater than 93°C (200°F), the pump should be gradually warmed until its temperature is within 38°C (100°F) of intended operating temperature.
- Start pump. If flow is not achieved in 30 seconds shut-off immediately. “Dry” running a pump for extended periods of time will damage the pump. If fluid does not start to flow in 30 seconds, revisit the previous steps. If every step has been followed, manually fill

the pump with the process fluid or a lubricating fluid compatible with the process and restart the pump. If no fluid is flowing within 30 seconds shut the pump down and proceed to trouble shooting section of this document.

- One pump is operational, listen for any untoward noise, check for any significant vibration or indications of binding. If any of these are observed, the pump should be stopped immediately and a thorough check of the installation should be made to determine the cause. Correct any fault(s) prior to re-starting the pump.

- Check the shaft seal. If pump has mechanical seal(s), there should be no visible leakage. If pump has packing, there should be a steady leakage stream. Packing leakage should be reduced gradually by tightening the gland nuts ¼-turn at a time until a leakage rate of 40-60 drops per minute is achieved. This may take several hours and several adjustments, but it is required to ensure adequate packing and shaft life.

---

## SECTION 5 MAINTENANCE

---

### GENERAL MAINTENANCE

**CLEANING:** G Series pumps must be maintained and kept as clean as possible. This will allow for quick inspection, adjustment and repair work.

**LUBRICATION:** Use multi-purpose NLGI #2 grease on all lubrication fittings every 500 hours of operation. Do not over-grease. Applications involving extreme temperatures (high or low) may require other types of lubrication. Consult factory for specific lubrication recommendations.

**STORAGE:** If a pump is to be stored for more than six (6) months, the pump must be drained prior to storing. A light coat of light oil should be applied to all internal pump parts in order to prevent corrosion. Operators should also lubricate the fittings and apply grease to the pump shaft, while periodically rotating the pump shaft by hand one (1) complete revolution every 30 days to circulate the oil. Be sure to inspect the fastener torque before putting the pump in service after being stored.

### PACKING MAINTENANCE

**PACKING ADJUSTMENT:** Newly packed pumps require initial packing adjustments to control leakage. Small initial adjustments are needed to prevent over-tightening the packing gland. After initial startup, additional adjustments may be required. Finally, the packing should also be checked periodically and adjusted. Refer to "START UP" section for more detail.

**REMOVAL:**

1. Remove packing gland fasteners.
2. Slide the packing gland out of the stuffing box.
3. Remove the packing.
4. Remove packing retaining washer.

**INSTALLATION:**

1. Ensure packing is chemically compatible with the liquid being pumped; consult with factory recommendations.
2. Install packing retaining washer in the gland.
3. Lubricate packing rings with oil, grease or graphite to aid with assembly.
4. Stagger the packing joints from one side of the shaft to the other. The joints of adjacent strands should never be in line with each other.
5. Install the packing gland, fasteners and nuts.
6. Ensure that the gland is installed squarely and that the nuts are tightened evenly.
7. Tighten the nuts until packing gland contacts packing. Final adjustment should be made per "START UP" procedure.

**COMPONENT SEAL MAINTENANCE**

**REMOVAL:**

1. Remove bearing housing (see Disassembly Section).
2. If installed, remove all flush lines
3. Remove packing gland fasteners.
4. Slide the packing gland out of the stuffing box.
5. Remove the seal components.
6. Remove the pipe plug in the bracket.
7. Loosen the two (2) set screws on the mechanical seal collar.
8. Remove the mechanical seal collar.

**INSTALLATION:**

**NOTE:** Never touch mechanical seal faces with anything except clean hands or a clean cloth. Small particles can scratch and damage the seal faces resulting in seal leakage.

1. Clean the rotor shaft and the seal housing bore. Make sure they are free of dirt, burrs and scratches. Using emery paper, gently smooth the leading edge of the shaft's diameter.
2. A tapered sleeve is required over the shaft locknut threads to prevent damage of the seal during installation. Slide the tapered sleeve on to the shaft.
3. Coat the tapered sleeve and the inside diameter of the rotary members of the seal generously with light oil.
4. Place the rotary member of the seal onto the shaft over the tapered sleeve (mechanical seal collar first.) Position the rotary member so that the set screws of the mechanical seal collar are directly in-line with the seal access hole on the side of the bracket. For Type 1 seals, use the second hole from the seal housing bore face. For Type 9 seals, use the first hole from the seal housing bore face. For all other seal types, use the seal manufacturer's recommended working height when setting the mechanical seal collar. Do not tighten the seal collar set screws at this time.
5. Install the stationary seal face followed by the seal gland loosely onto the shaft. Do not install gland nuts at this time.
6. Reinstall the bearing housing (see Reassembly Section.)
7. Adjust the end clearance (see Reassembly Section.)

8. After the rotor end clearance is set, ensure the mechanical seal collar is directly in line with the proper seal access hole and tighten the mechanical seal collar using two (2) or four (4) set screws, depending upon seal type.
9. Install pipe plug on bracket.
10. For stationary O-ring seal seats, lubricate the outer diameter of the O-ring with light oil.
11. Install the stationary seal face.
12. Install the packing gland, fasteners and nuts.
13. Tighten nuts securely and evenly.
14. As required, connect flush line.

**CARTRIDGE SEAL MAINTENANCE**

**REMOVAL:**

1. Remove bearing housing (see Disassembly Section).
2. If installed, disconnect all flush lines or barrier fluid tubes.
3. Loosen the set screws on the seal collar to free the cartridge seal from the shaft.
4. Remove the two (2) gland fasteners.
5. Slide cartridge seal out through bearing housing.

**INSTALLATION:**

1. Clean the rotor shaft and the seal housing bore. Make sure they are free of dirt, burrs and scratches. Using emery paper, gently smooth the leading edge of the shaft's diameter.
2. A tapered sleeve is required over the shaft locknut threads in order to prevent damage to the seal during installation. Slide the tapered sleeve on to the shaft.
3. Coat the tapered sleeve and the inside diameter of the seal generously with light oil.
4. Slide the cartridge seal over the tapered sleeve until it contacts the seal chamber face.
5. Remove the tapered sleeve from the shaft.
6. Reinstall the bearing housing (see Assembly Section).
7. Adjust the end clearance (see Assembly Section).
8. Install the gland fasteners and nuts.
9. Turn the shaft several times while the gland is loose to the center seal.

10. Tighten nuts securely and evenly.
11. Lock the cartridge seal drive collar to shaft and remove to clear the drive collar.
12. Turn shaft by hand or bump motor in order to test the rotation and to check the drive collar for run-out.
13. As required, connect flush line.

**NOTE:** For maximum seal life and increased seal retention, a flush line is recommended.

**BEARING HOUSING REMOVAL:**

1. Insert a length of brass through the port opening and in-between the rotor teeth in order to lock the pump and secure the shaft from turning.
2. Bend the lock washer tang upwards.
3. Using a spanner wrench, remove lock nut and lock washer from shaft.
4. Loosen the two (2) set screws in the face of the bearing housing and remove the bearing housing assembly from the bracket.
5. Remove the two (2) semi-round rings under the inner spacer collar from the shaft.

**NOTE:** There are no semi-round rings on the G1-2, G1-4, G1-133 or G1-222 models.

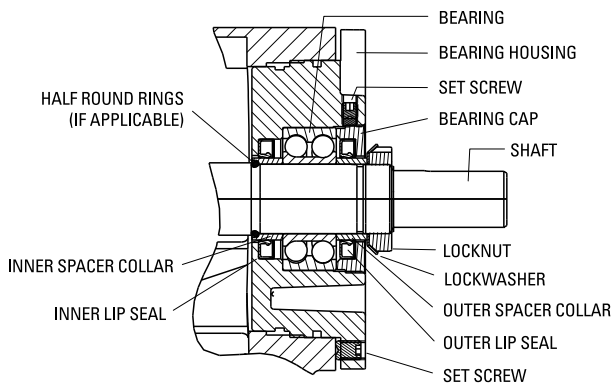

FIGURE G – G1-2 THROUGH G1-82 BEARING HOUSING ASSEMBLY

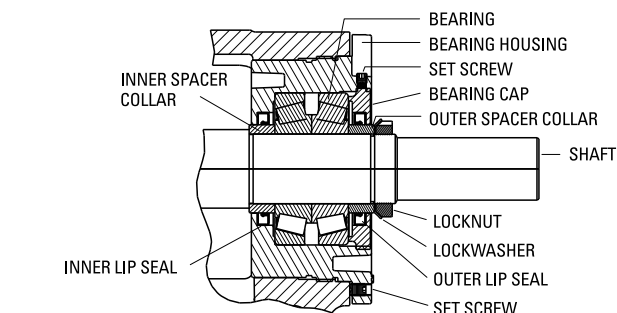

FIGURE H – G1-133 THROUGH G1-222 BEARING HOUSING ASSEMBLY

**WET END DISASSEMBLY:**

1. Mark the head and casing prior to disassembly as this will ensure proper reassembly. The idler pin must be positioned an equal distance between the port connections in order to allow for proper flow of liquid through the pump.
2. Remove the head from pump. **WARNING:** Protect the idler from falling as it may become loose during removal of the head.
3. Remove the idler and bushing assembly.
4. Remove seal or packing (see Maintenance Section).
5. Carefully remove the rotor and shaft to avoid damaging bracket bushing.
6. Remove the case from the bracket, as necessary.
7. Clean all parts thoroughly and examine the parts for wear or damage. Replace bracket bushings, idler bushings and idler pins, as necessary.

**BEARING HOUSING DISASSEMBLY:**

1. Loosen the two (2) radial set screws from the bearing housing end cap.
2. Using a spanner wrench, loosen the bearing housing end cap.
3. Remove outer bearing spacer collar.
4. Remove the double-row ball bearing (G1-2 through G1-82 models) or tapered roller bearings (G1-133 and G-222 models).
5. Remove the inner bearing spacer collar.
6. Clean all parts thoroughly and examine the parts for wear or damage. Replace lip seals and bearings, as necessary. It is recommended to replace the lip seals whenever replacing the bearings.

**PRESSURE RELIEF VALVE DISASSEMBLY:**

1. Place a mark on the valve and head prior to disassembly in order to ensure proper reassembly.
2. Remove the pressure relief valve cap.
3. Measure and record the extension length of the adjusting screw.
4. Loosen the pressure relief valve lock nut and then back out pressure relief valve bonnet and adjusting screw until the spring pressure is released.
5. Remove, clean and inspect all parts (i.e., bonnet, spring guide, spring and poppet) for wear or damage and replace as needed.

**BEARING HOUSING ASSEMBLY:**

1. Clean all parts thoroughly.
2. Install the bearing housing lip seal. Refer to Figure G and Figure H for proper orientation.
3. Insert the bearings into the housing. It is best practice to pack the bearings with NLGI #2 multi-purpose grease (or equivalent) before installation. G1-2 through G1-82 use one (1) double-row ball bearing. G1-133 and G-222 use two (2) tapered roller bearings installed with the large end of inner races together. Refer to Figure G and Figure H for proper installation.
4. Install the bearing cap lip seal. Refer to Figure G and Figure H for proper orientation.
5. Install the end-cap into the bearing housing. For G1-133 and G1-222 models, make sure to tighten completely against the outer race of the bearing.
6. Insert the outer bearing spacer collar into the end cap.
7. Use two (2) bearing housing inserts and two (2) set screws to lock the end cap in place.  
**NOTE:** Bearing housing inserts must be used to prevent damage of the end cap threads.
8. Insert the inner bearing spacer collar. For G1-24 through G1-82 models, the recessed end of the inner bearing spacer collar must face rotor.

**WET END ASSEMBLY:**

1. Clean all parts thoroughly.
2. Install the bracket bushing. If the bracket bushing has a lubrication groove, install the bushing with lubrication groove towards the bottom of the bracket. Carbon graphite bushings require additional precautions during installation to prevent cracking:
  - a. Use a press for installation.
  - b. Lightly lubricate the bushing and the bore.
  - c. Ensure bushing is aligned straight before starting.
  - d. Do not stop the pressing operation until bushing is in the proper position; starting and stopping will result in a cracked bushing.
  - e. Check bushing for cracks after installation.
3. Install the bracket gasket on the bracket, aligning the holes with the bolt pattern.

\*For stainless steel pumps, factory recommends a 149°C (300°F) temperature difference between the head and idler pin prior to installation.

\*\*For stainless steel pumps fitted with carbon graphite bushings, factory recommends heating the idler to 93°C (200°F) prior to installing bushings.

\*\*\*For pumps with carbon steel and iron externals only.

4. Attach the case to the bracket.
5. Coat the rotor shaft assembly with light oil.
6. Insert the end of the shaft into the bracket bushing by adjusting the shaft from right to left. Slowly push the rotor into the casing.
7. Press the idler pin into the head.

**NOTE:** Idler pin cooling port should face the crescent while aligning the cross port with the appropriate porting in the head casting.\*\*\*

The idler pin must be recessed 0.010" - 0.030" below the face of the crescent. Refer to Figure J.\*

**NOTE:** Install the NPT plug on the suction side of dovetail located on head casting.\*\*\*

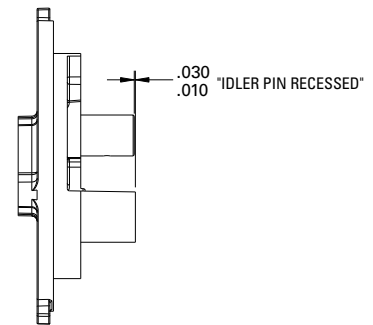

FIGURE J – IDLER PIN POSITION

8. Install the idler bushing. Carbon graphite bushings require additional precautions during installation to prevent cracking\*\*:
  - a. Use a press for installation.
  - b. Lightly lubricate the bushing and the bore.
  - c. Ensure bushing is aligned straight before starting.
  - d. Do not stop the pressing operation until bushing is in the proper position; starting and stopping will result in a cracked bushing.
  - e. Check bushing for cracks after installation.

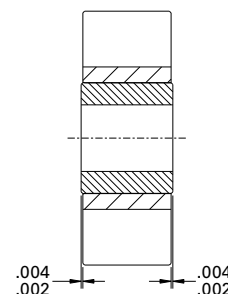

FIGURE K – IDLER BUSHING PROTRUSION

9. Coat the idler pin with light oil.
10. Place the idler and bushing assembly on the idler pin.
11. Install the head gasket on the head, aligning the holes with the bolt pattern.
12. Install the head/idler assembly.
13. Locate the markings previously placed on the pump head and casing to ensure proper reassembly. Ensure that the idler pin is positioned equally between port connections as this will allow for liquid to flow properly through the pump. Tighten head fasteners evenly.
14. Install mechanical seal or packing (see Maintenance Section).

### BEARING HOUSING INSTALLATION:

1. Place a pair of semi-round rings on the shaft and slide the inner bearing spacer collar over semi-round rings to lock in place.
- NOTE:** There are no semi-round rings on G1-2, G1-4, G1-133 and G1-222 models.
2. Place the lock washer and lock nut on the shaft with the small end of the locknut facing the bearing. Insert a length of brass between rotor teeth to keep shaft from turning. Tighten lock nut per torque values in table below.

Pump Model	Torque Value
G1-2	81 N•m (60 ft-lbs)
G1-4	
G1-24	156 N•m (115 ft-lbs)
G1-32	
G1-55	
G1-69	
G1-82	190 N•m (140 ft-lbs)
G1-133	244 N•m (180 ft-lbs)
G1-222	

3. Stake one (1) tang of lock washer into the slot of lock nut after torquing. Failure to properly torque the lock nut or engage the lock washer tang could result in premature bearing failure and damage to the pump. Finally, remove the length of the brass from the gear teeth.
4. Lubricate all grease fittings with NLGI #2 multi-purpose grease.

### END-CLEARANCE ADJUSTMENT:

G Series pumps rely on proper internal clearances for efficient operation. The required end clearance dimension depends on the temperature and viscosity of the fluid being pumped as well as the material of construction and size of the pump. The tables below shows the end clearance dimensions needed to adjust the gap between the rotor/idler and head of the G Series gear pump.

1. Loosen bearing housing set screws (2) in the face of the bearing housing flange enough so that they do not interfere with the bearing housing rotation during end clearance setting.
2. By hand or with a small spanner wrench, spin the shaft to find the rotor to head zero clearance setting.
  - a. Turn the bearing housing clockwise to move the rotor into the head, and counter clock wise to move it away from the head.
  - b. Turn the bearing housing clockwise until the shaft becomes difficult to spin with the spanner wrench or cannot be spun by hand.
  - c. Loosen the bearing housing slightly until the shaft will spin by hand with a slight drag on the head. This drag is caused by contact between the end of the rotor tooth and the head. This is the Zero Clearance point.

**NOTE:** Proper end clearance adjustment is very critical to pump performance and reliability. The zero setting should never be established by forcing the rotor into the head until the shaft will no longer spin. This will lead to high horsepower draw, rubbing during operation, and the potential for the pump to seize up. Never operate a G Series pump with zero clearance.

3. Make a continuous line on the bracket and bearing housing outside diameter to mark the zero clearance point. This will be the reference for zero end clearance.
4. Make another line on the bracket by measuring the correct radial distance from the first line on the bracket based on the size and clearance of the pump. The correct radial distance can be found in the End Clearance Setting Table for the appropriate size and material of pump. This second line will always be made to the left of the first line when looking from the shaft end of the pump.
5. Rotate the bearing housing counter clockwise so that the line on the bearing housing aligns with the second line on the bracket.

**CAST IRON/CARBON STEEL EXTERNALS (G1-W, G1-C)**

Pump Model	Clearance	Viscosity (cSt)	TEMP C (F)	Radial Distance on OD of Bearing Housing mm (inches)	Additional Length on OD Brg. Housing for .001" End Cl. (inches)
<b>G1-2/4 Iron and Steel Internals (G1-WW, G1-CC)</b>	A	Up to 540	Thru 107 (Thru 225)	19.1 (0.75)	0.22
	B		108-232 (226-450)	41.4 (1.63)	
	C		233-301 (451-575)	52.6 (2.07)	
	D	540 - 5,400	302-343 (576-650)	63.8 (2.51)	
	E	5,400 - 431,000		63.8 (2.51)	
<b>G1-24/32 Iron Internals (G1-WW, G1-WD, G1-CW, G1-CD)</b>	A	Up to 160	Thru 107 (Thru 225)	31.8 (1.25)	0.25
	B		108-149 (226-300)	50.8 (2)	
	C	160 - 1,600	150-232 (301-450)	63.5 (2.5)	
	D	1,600 - 16,000	233-343 (451-650)	95.3 (3.75)	
	E	16,000 - 431,000		127.0 (5)	
<b>G1-24/32 Steel Internals (G1-WC, G1-CC)</b>	A	Up to 160	Thru 107 (Thru 225)	31.8 (1.25)	0.25
	B	160 - 1,600	108-232 (226-450)	63.5 (2.5)	
	C	1,600 - 16,000	233-343 (451-650)	95.3 (3.75)	
	D			127.0 (5)	
	E			127.0 (5)	
<b>G1-55/69 Iron Internals (G1-WW, G1-CW)</b>	A	Up to 160	Thru 107 (Thru 225)	31.8 (1.25)	0.25
	B		108-149 (226-300)	50.8 (2)	
	C	160 - 1,600	150-232 (301-450)	63.5 (2.5)	
	D	1,600 - 16,000	233-302 (451-575)	82.6 (3.25)	
	E		303-343 (576-650)	108.0 (4.25)	
	F	16,000 - 431,000		127.0 (5)	
<b>G1-55/69 Steel Internals (G1-WC, G1-CC)</b>	A	Up to 160	Thru 107 (Thru 225)	31.8 (1.25)	0.25
	B	160 - 1,600	108-232 (226-450)	63.5 (2.5)	
	C	1,600 - 16,000	233-301 (451-575)	82.6 (3.25)	
	D		302-343 (576-650)	127.0 (5)	
	E			127.0 (5)	
<b>G1-82 Iron Internals (G1-WD, G1-CD)</b>	A	Up to 160	Thru 107 (Thru 225)	31.8 (1.25)	0.25
	B	160 - 1,600	108-232 (226-450)	63.5 (2.5)	
	C	1,600 - 16,000	233-301 (451-575)	95.3 (3.75)	
	D		302-343 (576-650)	127.0 (5)	
	E	16,000 - 431,000		127.0 (5)	
<b>G1-133/222 Iron Internals (G1-WD, G1-CD)</b>	A	Up to 160	Thru 107 (Thru 225)	78.7 (3.1)	0.31
	B	160 - 1,600	108-232 (226-450)	118.1 (4.65)	
	C	1,600 - 16,000	233-343 (451-650)	157.5 (6.2)	
	D	16,000 - 431,000		196.9 (7.75)	

NOTE: For pumps with cast iron and carbon steel externals, steel rotors are recommended above the following viscosities:

	G1-2	G1-4	G-24	G1-32	G1-55	G1-69
<b>SSU</b>	25,000	7,500	25,000	75,000	25,000	2,500
<b>cSt</b>	5,500	1,650	5,500	16,500	5,500	550

## STAINLESS STEEL EXTERNALS (G1-S)

Pump Model	Clearance	Viscosity (cSt)	TEMP C (F)	Radial Distance on OD of Bearing Housing mm (inches)	Additional Length on OD Brg. Housing for .001" End Cl. (inches)
<b>G1-2/4 Stainless Steel Internals (G1-SS)</b>	A	Up to 540	Thru 107 (Thru 225)	28.4 (1.12)	0.22
	B		108-149 (226-300)	56.4 (2.22)	
	C	540 - 5,400	150-260 (301-500)	73.2 (2.88)	
	D	5,400 - 431,000		73.2 (2.88)	
<b>G1-24/32 Stainless Steel Internals (G1-SS)</b>	A	Up to 1,600	Thru 107 (Thru 225)	50.8 (2)	0.25
	B		108-177 (226-350)	82.6 (3.25)	
	C	1,600 - 16,000	178-260 (351-500)	114.3 (4.5)	
	D	16,000 - 431,000		146.1 (5.75)	
<b>G1-55/69 Stainless Steel Internals (G1-SS)</b>	A	Up to 1,600	Thru 107 (Thru 225)	50.8 (2)	0.25
	B		108-177 (226-350)	82.6 (3.25)	
	C	1,600 - 16,000	178-260 (351-500)	114.3 (4.5)	
	D	16,000 - 431,000		146.1 (5.75)	
<b>G1-82 Stainless Steel Internals (G1-SN)</b>	A	Up to 160	Thru 107 (Thru 225)	63.5 (2.5)	0.25
	B	160 - 1,600	108-163 (226-325)	95.3 (3.75)	
	C	1,600 - 16,000	163-260 (326-500)	127.0 (5)	
	D	16,000 - 431,000		158.8 (6.25)	
<b>G1-133/222 Stainless Steel Internals (G1-SN)</b>	A	Up to 1,600	Thru 135 (thru 275)	78.7 (3.1)	0.31
	B	1,600 - 16,000	136-260 (276-500)	118.1 (4.65)	
	C	16,000 - 431,000		196.9 (7.75)	

**NOTE:** Coat all threads with anti-seize compound for Stainless Steel, Cast Iron and Carbon Steel.

### **PRESSURE RELIEF VALVE ASSEMBLY:**

1. Clean all parts thoroughly.
2. Install the poppet.
3. Insert the required springs.
4. Insert the spring guide.
5. Install the bonnet with a gasket. Securely tighten the bonnet.
6. Install adjusting screw and lock nut.
7. Tighten the adjustment screw to original setting.
8. Install the cap and gasket. Securely tighten the gasket.
9. Attach the pressure relief valve to the head using gaskets.

10. If a new spring is installed or if the pressure setting is to be changed, the following instructions must be carefully followed:

- a. Carefully remove the valve cap covering the adjusting screw.
- b. Loosen the adjusting screw lock nut.
- c. Install a pressure gauge in the discharge line.
- d. Turn the adjusting screw inward (clockwise) to increase pressure and outward (counterclockwise) to decrease pressure.
- e. With the discharge line valve closed (at a point beyond the pressure gauge), the gauge will show the maximum pressure (that the pressure relief valve will allow) while the pump is in operation.



**G1-2\_4**

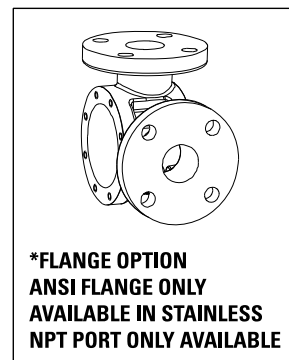
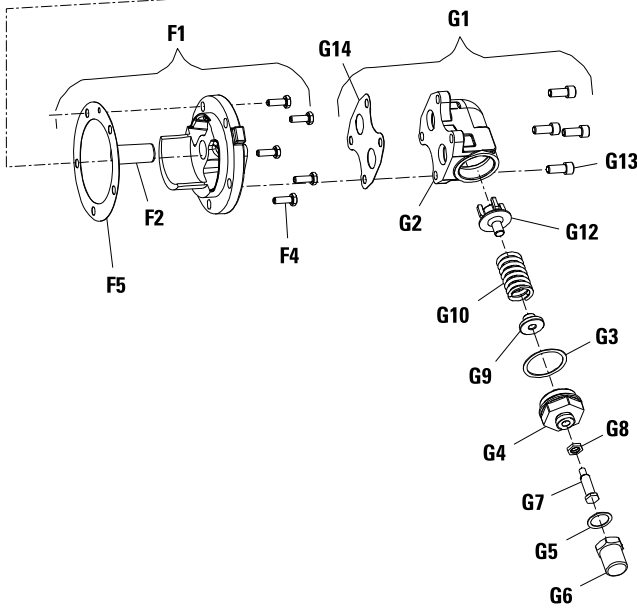
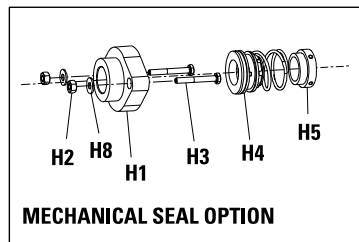
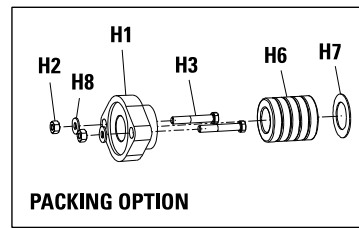
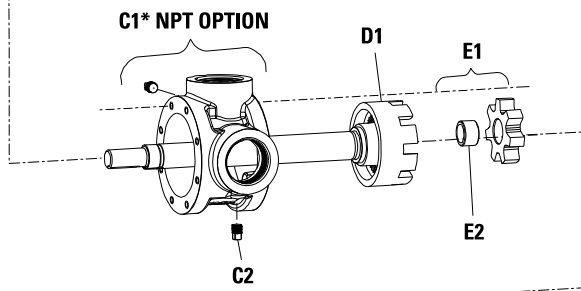
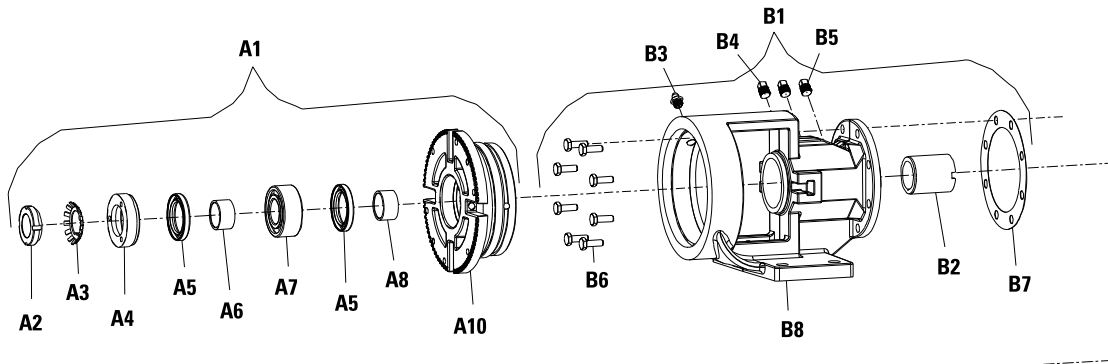

LM0002 REV. D

Item	Description	G1-2	G1-4	Qty.	Material
A1	HOUSING, BEARING ASSEMBLY (INCLUDES A2 THRU A13)	0020-1000-110		1	CAST IRON
A2	LOCKNUT, SHAFT	0020-1710-230		1	STEEL
A3	LOCKWASHER, SHAFT	0020-1720-230		1	STEEL
A4	ENDCAP, BEARING HOUSING	0020-1200-230		1	STEEL
A5	LIP SEAL, BEARING HOUSING	0020-1900-900		2	BUNA-N
A6	COLLAR, OUTER BEARING SPACER	0020-1300-230		1	STEEL
A7	BEARING	0020-1400-230		1	STEEL
A8	COLLAR, INNER BEARING SPACER	0020-1300-230		1	STEEL
A10	HOUSING, BEARING	0020-1100-110		1	CAST IRON
A11	SET SCREW (1/4"-20 X 5/8"), BEARING HOUSING (NOT SHOWN)	S57U250625WA6L7		2	STEEL
A12	SET SCREW (5/16"-18 X 5/8"), END CAP (NOT SHOWN)	S57U313625WA6L7		2	STEEL
A13	INSERT, BEARING HOUSING (NOT SHOWN)	0020-1790-400		2	NYLON
B1	BRACKET, ASSEMBLY (INCLUDES B2 THRU B8)	0020-2000-110		1	CAST IRON/CARBON GRAPHITE
		0020-2010-110		1	CAST IRON/BRONZE
B2	BUSHING, BRACKET	0020-2800-300		1	CARBON GRAPHITE
		0020-2800-320		1	BRONZE
B3	FITTING, GREASE (1/8" NPT)	GRSF-013NST-230		1	STEEL
B4	PLUG, PIPE (1/8" NPT)	PLUG-013NSH-230		2	STEEL
B5	PLUG, PIPE (1/8" NPT) (USED WITH LUBRICATED BUSHING)	PLUG-013NSH-230		1	STEEL
	FITTING, GREASE PIN (1/8" NPT) (USED WITH NON-LUBRICATED BUSHING)	GRSF-013NST-230		1	STEEL
B6	SCREWS (5/16"-18 X 3/4"), BRACKET	S01C312750WA2A2		8	STEEL
B7	GASKET, BRACKET	0020-2900-950		1	INTERFACE TS-9003
B8	BRACKET	0020-2100-110		1	CAST IRON
C1	CASE, 1.5" NPT KIT (INCLUDES B6, B7, C2, F4, F5)	0020-3000-110		1	CAST IRON
C2	PLUG, PIPE (1/8" NPT)	PLUG-013NSH-230		2	STEEL
D1	ROTOR, ASSEMBLY (A/B CLEARANCE)	0020-4000-110	0040-4000-110	1	CAST IRON/STEEL
	ROTOR, ASSEMBLY (C CLEARANCE)	0020-4002-110	0040-4002-110	1	CAST IRON/STEEL
	ROTOR, ASSEMBLY (D CLEARANCE)	0020-4003-110	0040-4003-110	1	CAST IRON/STEEL
	ROTOR, ASSEMBLY (E CLEARANCE)	0020-4004-130	0040-4004-130		STEEL
E1	GEAR, IDLER ASSEMBLY	0020-5000-110	0040-5000-110	1	CAST IRON/CARBON GRAPHITE
		0020-5010-110	0040-5010-110	1	CAST IRON/BRONZE
E2	BUSHING, IDLER	0020-5800-300	0040-5800-300	1	CARBON GRAPHITE
		0020-5800-320	0040-5800-320	1	BRONZE
F1	HEAD, KIT (INCLUDES F2 THRU F5)	0020-6010-110	0040-6010-110	1	CAST IRON/STEEL
F2	PIN, IDLER	0020-6200-231	0040-6200-231	1	HARDENED STEEL
F4	CAPSCREW (5/16"-18 X 3/4"), HEAD	S01C312750WA2A2		5	STEEL
F5	GASKET, HEAD	0020-6900-950		1	INTERFACE TS-9003
G1	VALVE, COVER ASSEMBLY (INCLUDES G2, G13, AND G14)	0020-7000-230		1	STAINLESS STEEL/STEEL
	VALVE, ASSEMBLY-75 PSI (INCLUDES G2 THRU G14)	0020-7001-110		1	CAST IRON
	VALVE, ASSEMBLY-125 PSI (INCLUDES G2 THRU G14)	0020-7002-110		1	CAST IRON
	VALVE, ASSEMBLY-200 PSI (INCLUDES G2 THRU G14)	0020-7003-110		1	CAST IRON
G2	VALVE, BODY	0020-7100-110		1	CAST IRON
	VALVE, COVER (NOT SHOWN)	0020-7101-250		1	STAINLESS STEEL
G3	VALVE, GASKET BONNET	0020-7910-951		1	KLINGERSIL® C-4401
G4	VALVE, BONNET	0020-7200-110		1	CAST IRON
G5	VALVE, GASKET CAP	0020-7920-951		1	KLINGERSIL® C-4401
G6	VALVE, CAP	0020-7300-230		1	STEEL
G7	VALVE, ADJUSTMENT SCREW	0020-7700-230		1	STEEL
G8	VALVE, LOCK NUT	0020-7710-230		1	STEEL
G9	VALVE, SPRING GUIDE	0020-7500-230		1	STEEL
G10	VALVE, SPRING-75 PSI	0020-7600-250		1	STAINLESS STEEL
	VALVE, SPRING-125 PSI	0020-7601-250		1	STAINLESS STEEL
	VALVE, SPRING-200 PSI	0020-7602-250		1	STAINLESS STEEL
G12	VALVE, POPPET	0020-7400-110		1	CAST IRON
G13	CAPSCREW (5/16"-18 X 3/4"), VALVE	S14U312750WA6L7		4	STEEL
G14	GASKET, VALVE	0020-7900-950		1	INTERFACE TS-9003
H1	GLAND, PACKING	0020-8200-110		1	CAST IRON
H2	NUT (5/16"-18), PACKING GLAND	N04C312281WA2A2		2	STEEL
H3	CAPSCREW (5/16"-18), PACKING GLAND	S01C312B25CLOA1		2	STAINLESS STEEL
H4	TYPE 1, COMPONENT SEAL	0020-8000-900		1	BUNA-N
	TYPE 1, COMPONENT SEAL	0020-8000-910		1	VITON
	TYPE 9, COMPONENT SEAL	0020-8001-920		1	PTFE
H5	COLLAR, MECHANICAL SEAL ASSEMBLY	0020-8050-230		1	STEEL
H6	PACKING, KIT (INCLUDES H7)	0020-8100-925K		1	PTFE - GRAPHITE
H7	WASHER, PACKING RETAINING	0020-8150-230		1	STEEL
H8	WASHER, PACKING GLAND	W2337ACLOA1		2	STAINLESS STEEL

Item	Description	G1-2	G1-4	Qty.	Material
A1	HOUSING, BEARING ASSEMBLY (INCLUDES A2 THRU A13)	0020-1000-110		1	CAST IRON
A2	LOCKNUT, SHAFT	0020-1710-230		1	STEEL
A3	LOCKWASHER, SHAFT	0020-1720-230		1	STEEL
A4	ENDCAP, BEARING HOUSING	0020-1200-230		1	STEEL
A5	LIP SEAL, BEARING HOUSING	0020-1900-900		2	BUNA-N
A6	COLLAR, OUTER BEARING SPACER	0020-1300-230		1	STEEL
A7	BEARING	0020-1400-230		1	STEEL
A8	COLLAR, INNER BEARING SPACER	0020-1300-230		1	STEEL
A10	HOUSING, BEARING	0020-1100-110		1	CAST IRON
A11	SET SCREW (1/4"-20 X 5/8"), BEARING HOUSING (NOT SHOWN)	S57U250625WA6L7		2	STEEL
A12	SET SCREW (5/16"-18 X 5/8"), END CAP (NOT SHOWN)	S57U313625WA6L7		2	STEEL
A13	INSERT, BEARING HOUSING (NOT SHOWN)	0020-1790-400		2	NYLON
B1	BRACKET, ASSEMBLY (INCLUDES B2 THRU B8)	0020-2000-150		1	STAINLESS STEEL/CARBON GRAPHITE
B2	BUSHING, BRACKET	0020-2800-300		1	CARBON GRAPHITE
B3	FITTING, GREASE (1/8" NPT)	GRSF-013NST-230		1	STEEL
B4	PLUG, PIPE (1/8" NPT)	PLUG-013NSH-250		2	STAINLESS STEEL
B5	PLUG, PIPE (1/8" NPT)	PLUG-013NSH-250		1	STAINLESS STEEL
B6	SCREWS (5/16"-18 X 3/4"), BRACKET	S01C312750AA9A1		8	STAINLESS STEEL
B7	GASKET, BRACKET	0020-2900-950		1	INTERFACE TS-9003
B8	BRACKET	0020-2100-150		1	STAINLESS STEEL
C1	CASE, 1.5" ANSI KIT (INCLUDES B6, B7, C2, F4, F5)	0020-3001-150		1	STAINLESS STEEL
C2	PLUG, PIPE (1/8" NPT)	PLUG-013NSH-250		2	STAINLESS STEEL
D1	ROTOR, ASSEMBLY (A/B CLEARANCE)	0020-4000-155	0040-4000-155	1	STAINLESS STEEL
		0020-4000-176	0040-4000-176	1	NITRONIC 60/STAINLESS STEEL
		0020-4002-155	0040-4002-155	1	STAINLESS STEEL
		0020-4002-176	0040-4002-176	1	NITRONIC 60/STAINLESS STEEL
		0020-4003-155	0040-4003-155	1	STAINLESS STEEL
E1	GEAR, IDLER ASSEMBLY	0020-5000-255	0040-5000-255	1	STAINLESS STEEL/CARBON GRAPHITE
		0020-5000-276	0040-5000-276	1	NITRONIC 60/CARBON GRAPHITE
E2	BUSHING, IDLER	0020-5801-300	0040-5801-300	1	CARBON GRAPHITE
F1	HEAD, KIT (INCLUDES F2 THRU F5)	0020-6010-150	0040-6010-150	1	STAINLESS/HARDENED STAINLESS
F2	PIN, IDLER	0020-6200-254	0040-6200-254	1	HARDENED STAINLESS STEEL
F4	CAPSCREW (5/16"-18 X 3/4"), HEAD	S01C312750AA9A1		5	STAINLESS STEEL
F5	GASKET, HEAD	0020-6900-950		1	INTERFACE TS-9003
G1	VALVE, COVER ASSEMBLY (INCLUDES G2, G13, AND G14)	0020-7000-250		1	STAINLESS STEEL/STAINLESS STEEL
	VALVE, ASSEMBLY-75 PSI (INCLUDES G2 THRU G14)	0020-7001-150		1	STAINLESS STEEL
	VALVE, ASSEMBLY-125 PSI (INCLUDES G2 THRU G14)	0020-7002-150		1	STAINLESS STEEL
	VALVE, ASSEMBLY-150 PSI (INCLUDES G2 THRU G14)	0020-7003-150		1	STAINLESS STEEL
G2	VALVE, BODY	0020-7100-150		1	STAINLESS STEEL
	VALVE, COVER (NOT SHOWN)	0020-7101-250		1	STAINLESS STEEL
G3	VALVE, GASKET BONNET	0020-7910-951		1	KLINGERSIL® C-4401
G4	VALVE, BONNET	0020-7200-150		1	STAINLESS STEEL
G5	VALVE, GASKET CAP	0020-7920-951		1	KLINGERSIL® C-4401
G6	VALVE, CAP	0020-7300-250		1	STAINLESS STEEL
G7	VALVE, ADJUSTMENT SCREW	0020-7700-255		1	STAINLESS STEEL
G8	VALVE, LOCK NUT	0020-7710-255		1	STAINLESS STEEL
G9	VALVE, SPRING GUIDE	0020-7500-250		1	STAINLESS STEEL
G10	VALVE, SPRING-75 PSI	0020-7600-250		1	STAINLESS STEEL
	VALVE, SPRING-125 PSI	0020-7601-250		1	STAINLESS STEEL
	VALVE, SPRING-200 PSI	0020-7602-250		1	STAINLESS STEEL
G12	VALVE, POPPET	0020-7400-150		1	STAINLESS STEEL
G13	CAPSCREW (5/16"-18 X 3/4"), VALVE	S14U312750AA9A1		4	STAINLESS STEEL
G14	GASKET, VALVE	0020-7900-950		1	INTERFACE TS-9003
H1	GLAND, PACKING	0020-8200-150		1	STAINLESS STEEL
H2	NUT (5/16"-18), PACKING GLAND	N04C312281AA9A1		2	STAINLESS STEEL
H3	CAPSCREW (5/16"-18 X 3/4"), PACKING GLAND	S01C312B25CLOA1		2	STAINLESS STEEL
H4	TYPE 9, COMPONENT SEAL	0020-8001-920		1	PTFE
H6	PACKING, KIT (INCLUDES H7)	0020-8100-925K		1	PTFE - GRAPHITE
H7	WASHER, PACKING RETAINING	0020-8150-250		1	STAINLESS STEEL
H8	WASHER, PACKING GLAND	W2337ACLOA1		2	STAINLESS STEEL

Item	Description	G1-2	G1-4	Qty.	Material
A1	HOUSING, BEARING ASSEMBLY (INCLUDES A2 THRU A13)	0020-1000-110		1	CAST IRON
A2	LOCKNUT, SHAFT	0020-1710-230		1	STEEL
A3	LOCKWASHER, SHAFT	0020-1720-230		1	STEEL
A4	ENDCAP, BEARING HOUSING	0020-1200-230		1	STEEL
A5	LIP SEAL, BEARING HOUSING	0020-1900-900		2	BUNA-N
A6	COLLAR, OUTER BEARING SPACER	0020-1300-230		1	STEEL
A7	BEARING	0020-1400-230		1	STEEL
A8	COLLAR, INNER BEARING SPACER	0020-1300-230		1	STEEL
A10	HOUSING, BEARING	0020-1100-110		1	CAST IRON
A11	SET SCREW (1/4"-20 X 5/8"), BEARING HOUSING (NOT SHOWN)	S57U250625WA6L7		2	STEEL
A12	SET SCREW (5/16"-18 X 5/8"), END CAP (NOT SHOWN)	S57U313625WA6L7		2	STEEL
A13	INSERT, BEARING HOUSING (NOT SHOWN)	0020-1790-400		2	NYLON
B1	BRACKET, ASSEMBLY (INCLUDES B2 THRU B8)	0020-2000-130		1	CARBON STEEL/CARBON GRAPHITE
		0020-2010-130		1	CARBON STEEL/BRONZE
B2	BUSHING, BRACKET	0020-2800-300		1	CARBON GRAPHITE
		0020-2800-320		1	BRONZE
B3	FITTING, GREASE (1/8" NPT)	GRSF-013NST-230		1	STEEL
B4	PLUG, PIPE (1/8" NPT)	PLUG-013NSH-230		2	STEEL
B5	PLUG, PIPE (1/8" NPT) (USED WITH LUBRICATED BUSHING)	PLUG-013NSH-230		1	STEEL
	FITTING, GREASE PIN (1/8" NPT) (USED WITH NON-LUBRICATED BUSHING)	GRSF-013NST-230		1	STEEL
B6	SCREWS (5/16"-18 X 3/4"), BRACKET	S01C312750WA2A2		8	STEEL
B7	GASKET, BRACKET	0020-2900-950		1	INTERFACE TS-9003
B8	BRACKET	0020-2100-130		1	CARBON STEEL
C1	CASE, 1.5" ANSI KIT (INCLUDES B6, B7, C2, F4, F5)	0020-3001-130		1	CARBON STEEL
C2	PLUG, PIPE (1/8" NPT)	PLUG-013NSH-230		2	STEEL
D1	ROTOR, ASSEMBLY (A/B/C CLEARANCE)	0020-4000-130	0040-4000-170	1	CAST STEEL/STEEL
	ROTOR, ASSEMBLY (D CLEARANCE)	0020-4003-130	0040-4003-170	1	CAST STEEL/STEEL
	ROTOR, ASSEMBLY (E CLEARANCE)	0020-4004-130	0040-4004-170	1	CAST STEEL/STEEL
E1	GEAR, IDLER ASSEMBLY	0020-5000-110	0040-5000-110	1	CAST IRON/CARBON GRAPHITE
		0020-5010-110	0040-5010-110	1	CAST IRON/BRONZE
E2	BUSHING, IDLER	0020-5800-300	0040-5800-300	1	CARBON GRAPHITE
		0020-5800-320	0040-5800-320	1	BRONZE
F1	HEAD, KIT (INCLUDES F2 THRU F5)	0020-6010-130	0040-6010-130	1	CARBON STEEL/STEEL
F2	PIN, IDLER	0020-6200-231	0040-6200-231	1	HARDENED STEEL
F4	CAPSCREW (5/16"-18 X 3/4"), HEAD	S01C312750WA2A2		5	STEEL
F5	GASKET, HEAD	0020-6900-950		1	INTERFACE TS-9003
G1	VALVE, COVER ASSEMBLY (INCLUDES G2, G13, AND G14)	0020-7000-230		1	STAINLESS STEEL/STEEL
	VALVE, ASSEMBLY-75 PSI (INCLUDES G2 THRU G14)	0020-7001-130		1	CARBON STEEL
	VALVE, ASSEMBLY-125 PSI (INCLUDES G2 THRU G14)	0020-7002-130		1	CARBON STEEL
	VALVE, ASSEMBLY-200 PSI (INCLUDES G2 THRU G14)	0020-7003-130		1	CARBON STEEL
G2	VALVE, BODY	0020-7100-130		1	CARBON STEEL
	VALVE, COVER (NOT SHOWN)	0020-7101-250		1	STAINLESS STEEL
G3	VALVE, GASKET BONNET	0020-7910-951		1	KLINGERSIL® C-4401
G4	VALVE, BONNET	0020-7200-130		1	CARBON STEEL
G5	VALVE, GASKET CAP	0020-7920-951		1	KLINGERSIL® C-4401
G6	VALVE, CAP	0020-7300-230		1	STEEL
G7	VALVE, ADJUSTMENT SCREW	0020-7700-230		1	STEEL
G8	VALVE, LOCK NUT	0020-7710-230		1	STEEL
G9	VALVE, SPRING GUIDE	0020-7500-230		1	STEEL
	VALVE, SPRING-75 PSI	0020-7600-250		1	STAINLESS STEEL
	VALVE, SPRING-125 PSI	0020-7601-250		1	STAINLESS STEEL
G10	VALVE, SPRING-200 PSI	0020-7602-250		1	STAINLESS STEEL
	VALVE, POPPET	0020-7400-110		1	CAST IRON
G13	CAPSCREW (5/16"-18 X 3/4"), VALVE	S14U312750WA6L7		4	STEEL
G14	GASKET, VALVE	0020-7900-950		1	INTERFACE TS-9003
H1	GLAND, PACKING	0020-8200-110		1	CAST IRON
H2	NUT (5/16"-18), PACKING GLAND	N04C312281WA2A2		2	STEEL
H3	CAPSCREW (5/16"-18), PACKING GLAND	S01C312B25CLOA1		2	STAINLESS STEEL
	TYPE 1, COMPONENT SEAL	0020-8000-900		1	BUNA-N
H4	TYPE 1, COMPONENT SEAL	0020-8000-910		1	VITON
	TYPE 9, COMPONENT SEAL	0020-8001-920		1	PTFE
H5	COLLAR, MECHANICAL SEAL ASSEMBLY	0020-8050-230		1	STEEL
H6	PACKING, KIT (INCLUDES H7)	0020-8100-925K		1	PTFE - GRAPHITE
H7	WASHER, PACKING RETAINING	0020-8150-230		1	STEEL
H8	WASHER, PACKING GLAND	W2337ACLOA1		2	STAINLESS STEEL

**G1-24\_32**

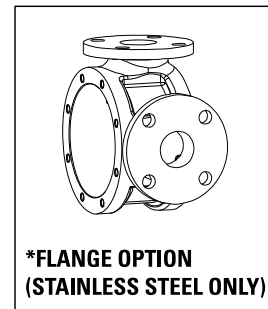
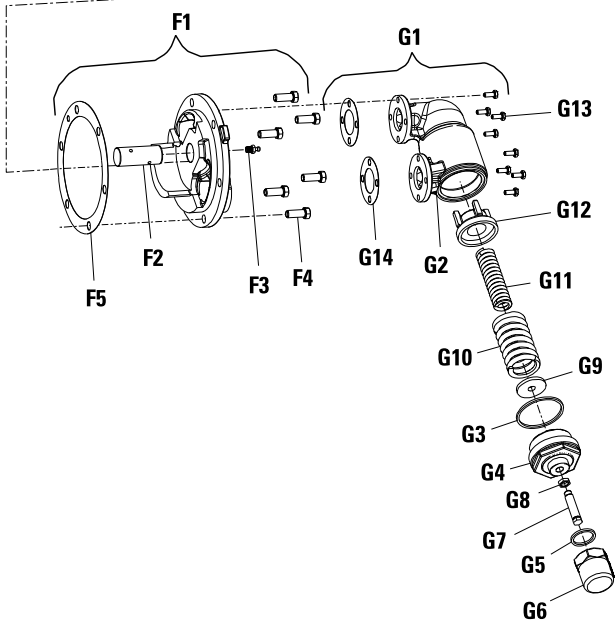
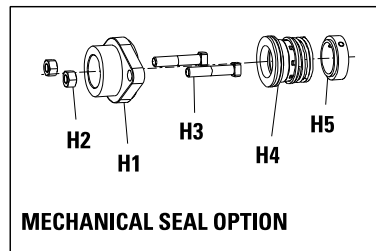
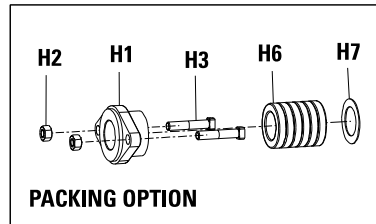
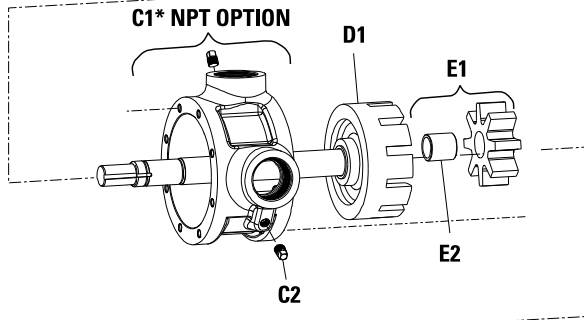
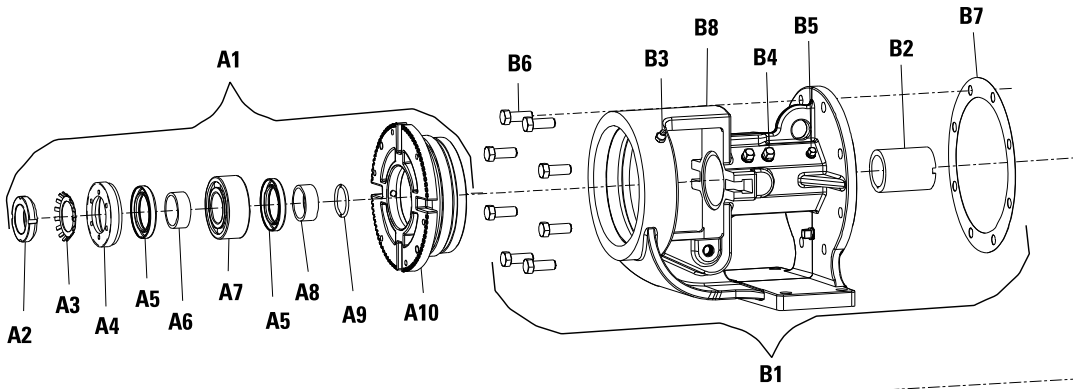

LM0004, REV. C

Item	Description	G1-24	G1-32	Qty.	Material
A1	HOUSING, BEARING ASSEMBLY (INCLUDES A2 THRU A13)	0240-1000-110		1	CAST IRON
A2	LOCKNUT, SHAFT	0240-1710-230		1	STEEL
A3	LOCKWASHER, SHAFT	0240-1720-230		1	STEEL
A4	ENDCAP, BEARING HOUSING	0240-1200-230		1	STEEL
A5	LIP SEAL, BEARING HOUSING	0240-1900-900		2	BUNA-N
A6	COLLAR, OUTER BEARING SPACER	0240-1300-230		1	STEEL
A7	BEARING	0240-1400-230		1	STEEL
A8	COLLAR, INNER BEARING SPACER	0240-1301-230		1	STEEL
A9	SEMI-ROUND RINGS	0240-1310-230		2	STEEL
A10	HOUSING, BEARING	0240-1100-110		1	CAST IRON
A11	SET SCREW (3/8"-16 X 1/2"), BEARING HOUSING (NOT SHOWN)	S57U375500WA6L7		2	STEEL
A12	SET SCREW (5/16"-18 X 5/16"), END CAP (NOT SHOWN)	S57U313313WA6L7		2	STEEL
A13	INSERT, BEARING HOUSING (NOT SHOWN)	0020-1790-400		2	NYLON
B1	BRACKET, ASSEMBLY (INCLUDES B2 THRU B8)	0240-2000-110		1	CAST IRON/CARBON GRAPHITE
		0240-2010-110		1	CAST IRON/BRONZE
B2	BUSHING, BRACKET	0240-2800-300		1	CARBON GRAPHITE
		0240-2800-320		1	BRONZE
B3	FITTING, GREASE (1/8" NPT)	GRSF-013NST-230		1	STEEL
B4	PLUG, PIPE (1/4" NPT)	PLUG-025NSH-230		3	STEEL
B5	PLUG, PIPE (1/8" NPT) (USED WITH LUBRICATED BUSHING)	PLUG-013NSH-230		1	STEEL
	FITTING, GREASE PIN (1/8" NPT) (USED WITH NON-LUBRICATED BUSHING)	GRSF-013NST-230		1	STEEL
B6	SCREWS (7/16"-14 X 1-1/8"), BRACKET	S01C438A12WA2A2		8	STEEL
B7	GASKET, BRACKET	0240-2900-950		1	INTERFACE TS-9003
B8	BRACKET	0240-2100-110		1	CAST IRON
C1	CASE, 2" NPT KIT (INCLUDES B6, B7, C2, F4, F5)	0240-3000-110		1	CAST IRON
C2	PLUG, PIPE (1/4" NPT)	PLUG-025NSH-230		2	STEEL
D1	ROTOR, ASSEMBLY (A/B CLEARANCE)	0240-4000-110	N/A	1	CAST IRON/STEEL
		N/A	0320-4000-120	1	DUCTILE IRON/STEEL
	ROTOR, ASSEMBLY (C CLEARANCE)	0240-4002-110	N/A	1	CAST IRON/STEEL
		N/A	0320-4002-120	1	DUCTILE IRON/STEEL
ROTOR, ASSEMBLY (D CLEARANCE)	0240-4003-110	N/A	1	CAST IRON/STEEL	
	N/A	0320-4003-120	1	DUCTILE IRON/STEEL	
E1	GEAR, IDLER ASSEMBLY	0240-4004-130	0320-4004-130	1	STEEL
		0240-5000-110	0320-5000-110	1	CAST IRON/CARBON GRAPHITE
E2	BUSHING, IDLER	0240-5010-110	0320-5010-110	1	CAST IRON/BRONZE
		0240-5800-300	0320-5800-300	1	CARBON GRAPHITE
F1	HEAD, KIT (INCLUDES F2 THRU F5)	0240-6010-110	0320-6010-110	1	CAST IRON/STEEL
F2	PIN, IDLER	0240-6200-231	0320-6200-231	1	HARDENED STEEL
F3	PLUG, PIPE (1/8" NPT) (USED WITH LUBRICATED BUSHING)	PLUG-013NSH-230		1	STEEL
	FITTING, GREASE PIN (1/8" NPT) (USED WITH NON-LUBRICATED BUSHING)	GRSF-013NST-230		1	STEEL
F4	CAPSCREW (7/16"-14 X 1-1/8"), HEAD	S01C438A12WA2A2		6	STEEL
F5	GASKET, HEAD	0240-6900-950		1	INTERFACE TS-9003
G1	VALVE, COVER ASSEMBLY (INCLUDES G2, G13 AND G14)	0240-7000-230		1	STAINLESS STEEL/STEEL
	VALVE, ASSEMBLY-50 PSI (INCLUDES G2 THRU G14)	0240-7001-110		1	CAST IRON
	VALVE, ASSEMBLY-80 PSI (INCLUDES G2 THRU G14)	0240-7002-110		1	CAST IRON
	VALVE, ASSEMBLY-150 PSI (INCLUDES G2 THRU G14)	0240-7003-110		1	CAST IRON
	VALVE, ASSEMBLY-200 PSI (INCLUDES G2 THRU G14)	0240-7004-110		1	CAST IRON
G2	VALVE, BODY	0240-7100-110		1	CAST IRON
	VALVE, COVER (NOT SHOWN)	0240-7101-250		2	STAINLESS STEEL
G3	VALVE, GASKET BONNET	0240-7910-951		1	KLINGERSIL® C-4401
G4	VALVE, BONNET	0240-7200-110		1	CAST IRON
G5	VALVE, GASKET CAP	0240-7920-951		1	KLINGERSIL® C-4401
G6	VALVE, CAP	0240-7300-110		1	CAST IRON
G7	VALVE, ADJUSTMENT SCREW	0240-7700-230		1	STEEL
G8	VALVE, LOCK NUT	0240-7710-230		1	STEEL
G9	VALVE, SPRING GUIDE	0240-7500-230		1	STEEL
G10	VALVE, SPRING LARGE (USED WITH 150 & 200 PSI VALVES)	0240-7602-250		1	STAINLESS STEEL
G11	VALVE, SPRING SMALL (USED WITH 50 PSI VALVES)	0240-7600-250		1	STAINLESS STEEL
	VALVE, SPRING SMALL (USED WITH 80 & 200 PSI VALVES)	0240-7601-250		1	STAINLESS STEEL
G12	VALVE, POPPET	0240-7400-110		1	CAST IRON
G13	CAPSCREW (5/16"-18 X .625), VALVE	S01C312625WA2A2		8	STEEL
G14	GASKET, VALVE	0240-7900-950		2	INTERFACE TS-9003
H1	GLAND, PACKING	0240-8200-110		1	CAST IRON
	GLAND, PACKING (TYPE 9)	0240-8201-110		1	CAST IRON
H2	NUT (7/16"-14), PACKING GLAND	N04C438375WA2A2		2	STEEL
H3	CAPSCREW (7/16"-14), PACKING GLAND	S01C438B50CLOA1		2	STAINLESS STEEL
H4	TYPE 1, COMPONENT SEAL	0240-8000-900		1	BUNA-N
	TYPE 1, COMPONENT SEAL	0240-8000-910		1	VITON
	TYPE 9, COMPONENT SEAL	0240-8001-920		1	PTFE
H5	COLLAR, MECHANICAL SEAL ASSEMBLY	0240-8050-230		1	STEEL
H6	PACKING, KIT (INCLUDES H7)	0240-8100-925K		1	PTFE - GRAPHITE
H7	WASHER, PACKING RETAINING	0240-8150-230		1	STEEL

Item	Description	G1-24	G1-32	Qty.	Material
A1	HOUSING, BEARING ASSEMBLY (INCLUDES A2 THRU A13)	0240-1000-110		1	CAST IRON
A2	LOCKNUT, SHAFT	0240-1710-230		1	STEEL
A3	LOCKWASHER, SHAFT	0240-1720-230		1	STEEL
A4	ENDCAP, BEARING HOUSING	0240-1200-230		1	STEEL
A5	LIP SEAL, BEARING HOUSING	0240-1900-900		2	BUNA-N
A6	COLLAR, OUTER BEARING SPACER	0240-1300-230		1	STEEL
A7	BEARING	0240-1400-230		1	STEEL
A8	COLLAR, INNER BEARING SPACER	0240-1301-230		1	STEEL
A9	SEMI-ROUND RINGS	0240-1310-230		2	STEEL
A10	HOUSING, BEARING	0240-1100-110		1	CAST IRON
A11	SET SCREW (3/8"-16 X 1/2"), BEARING HOUSING (NOT SHOWN)	S57U375500WA6L7		2	STEEL
A12	SET SCREW (5/16"-18 X 5/16"), END CAP (NOT SHOWN)	S57U313313WA6L7		2	STEEL
A13	INSERT, BEARING HOUSING (NOT SHOWN)	0020-1790-400		2	NYLON
B1	BRACKET, ASSEMBLY (INCLUDES B2 THRU B8)	0240-2000-150		1	STAINLESS STEEL/CARBON GRAPHITE
B2	BUSHING, BRACKET	0240-2800-300		1	CARBON GRAPHITE
B3	FITTING, GREASE (1/8" NPT)	GRSF-013NST-230		1	STEEL
B4	PLUG, PIPE (1/4" NPT)	PLUG-025NSH-250		3	STAINLESS STEEL
B5	PLUG, PIPE (1/8" NPT)	PLUG-013NSH-250		1	STAINLESS STEEL
B6	SCREWS (7/16"-14 X 1-1/8"), BRACKET	S01C438A12AA9A1		8	STAINLESS STEEL
B7	GASKET, BRACKET	0240-2900-950		1	INTERFACE TS-9003
B8	BRACKET	0240-2100-150		1	STAINLESS STEEL
C1	CASE, 2" ANSI KIT (INCLUDES B6, B7, C2, F4, F5)	0240-3001-150		1	STAINLESS STEEL
C2	PLUG, PIPE (1/4" NPT)	PLUG-025NSH-250		2	STAINLESS STEEL
D1	ROTOR, ASSEMBLY (A CLEARANCE)	0240-4000-155	0320-4000-155	1	STAINLESS STEEL
		0240-4000-176	0320-4000-176	1	NITRONIC 60/STAINLESS STEEL
		0240-4002-155	0320-4002-155	1	STAINLESS STEEL
		0240-4002-176	0320-4002-176	1	NITRONIC 60/STAINLESS STEEL
		0240-4003-155	0320-4003-155	1	STAINLESS STEEL
E1	GEAR, IDLER ASSEMBLY	0240-4003-176	0320-4003-176	1	NITRONIC 60/STAINLESS STEEL
		0240-5000-255	0320-5000-255	1	STAINLESS STEEL/CARBON GRAPHITE
E2	BUSHING, IDLER	0240-5000-276	0320-5000-276	1	NITRONIC 60/CARBON GRAPHITE
		0240-5801-300	0320-5801-300	1	CARBON GRAPHITE
F1	HEAD, KIT (INCLUDES F2, F4, F5)	0240-6010-150	0320-6010-150	1	STAINLESS/HARDENED STAINLESS
F2	PIN, IDLER	0240-6200-254	0320-6200-254	1	HARDENED STAINLESS STEEL
F4	CAPSCREW (7/16"-14 X 1-1/8"), HEAD	S01C438A12AA9A1		6	STAINLESS STEEL
F5	GASKET, HEAD	0240-6900-950		1	INTERFACE TS-9003
G1	VALVE, COVER ASSEMBLY (INCLUDES G2, G13 AND G14)	0240-7000-250		1	STAINLESS STEEL/STAINLESS STEEL
	VALVE, ASSEMBLY-50 PSI (INCLUDES G2 THRU G14)	0240-7001-150		1	STAINLESS STEEL
	VALVE, ASSEMBLY-80 PSI (INCLUDES G2 THRU G14)	0240-7002-150		1	STAINLESS STEEL
	VALVE, ASSEMBLY-150 PSI (INCLUDES G2 THRU G14)	0240-7003-150		1	STAINLESS STEEL
G2	VALVE, BODY	0240-7100-150		1	STAINLESS STEEL
	VALVE, COVER (NOT SHOWN)	0240-7101-250		2	STAINLESS STEEL
G3	VALVE, GASKET BONNET	0240-7910-951		1	KLINGERSIL® C-4401
G4	VALVE, BONNET	0240-7200-150		1	STAINLESS STEEL
G5	VALVE, GASKET CAP	0240-7920-951		1	KLINGERSIL® C-4401
G6	VALVE, CAP	0240-7300-150		1	STAINLESS STEEL
G7	VALVE, ADJUSTMENT SCREW	0240-7700-255		1	STAINLESS STEEL
G8	VALVE, LOCK NUT	0240-7710-255		1	STAINLESS STEEL
G9	VALVE, SPRING GUIDE	0240-7500-250		1	STAINLESS STEEL
G10	VALVE, SPRING LARGE (USED WITH 150 & 200 PSI VALVES)	0240-7602-250		1	STAINLESS STEEL
G11	VALVE, SPRING SMALL (USED WITH 50 PSI VALVES)	0240-7600-250		1	STAINLESS STEEL
	VALVE, SPRING SMALL (USED WITH 80 & 200 PSI VALVES)	0240-7601-250		1	STAINLESS STEEL
G12	VALVE, POPPET	0240-7400-150		1	STAINLESS STEEL
G13	CAPSCREW (5/16"-18 X .625), VALVE	S01C312625AA9A1		8	STAINLESS STEEL
G14	GASKET, VALVE	0240-7900-950		2	INTERFACE TS-9003
H1	GLAND, PACKING	0240-8201-150		1	STAINLESS STEEL
H2	NUT (7/16"-14), PACKING GLAND	N04C438375AA9A1		2	STAINLESS STEEL
H3	CAPSCREW (7/16"-14), PACKING GLAND	S01C438B50CLOA1		2	STAINLESS STEEL
H4	TYPE 9, COMPONENT SEAL	0240-8001-920		1	PTFE
H6	PACKING, KIT (INCLUDES H7)	0240-8100-925K		1	PTFE - GRAPHITE
H7	WASHER, PACKING RETAINING	0240-8150-250		1	STAINLESS STEEL

Item	Description	G1-24	G1-32	Qty.	Material
A1	HOUSING, BEARING ASSEMBLY (INCLUDES A2 THRU A13)	0240-1000-110		1	CAST IRON
A2	LOCKNUT, SHAFT	0240-1710-230		1	STEEL
A3	LOCKWASHER, SHAFT	0240-1720-230		1	STEEL
A4	ENDCAP, BEARING HOUSING	0240-1200-230		1	STEEL
A5	LIP SEAL, BEARING HOUSING	0240-1900-900		2	BUNA-N
A6	COLLAR, OUTER BEARING SPACER	0240-1300-230		1	STEEL
A7	BEARING	0240-1400-230		1	STEEL
A8	COLLAR, INNER BEARING SPACER	0240-1301-230		1	STEEL
A9	SEMI-ROUND RINGS	0240-1310-230		2	STEEL
A10	HOUSING, BEARING	0240-1100-110		1	CAST IRON
A11	SET SCREW (3/8"-16 X 1/2"), BEARING HOUSING (NOT SHOWN)	S57U375500WA6L7		2	STEEL
A12	SET SCREW (5/16"-18 X 5/16"), END CAP (NOT SHOWN)	S57U313313WA6L7		2	STEEL
A13	INSERT, BEARING HOUSING (NOT SHOWN)	0020-1790-400		2	NYLON
B1	BRACKET, ASSEMBLY (INCLUDES B2 THRU B8)	0240-2000-130		1	CARBON STEEL/CARBON GRAPHITE
		0240-2010-130		1	CARBON STEEL/BRONZE
B2	BUSHING, BRACKET	0240-2800-300		1	CARBON GRAPHITE
		0240-2800-320		1	BRONZE
B3	FITTING, GREASE (1/8" NPT)	GRSF-013NST-230		1	STEEL
B4	PLUG, PIPE (1/4" NPT)	PLUG-025NSH-230		3	STEEL
B5	PLUG, PIPE (1/8" NPT) (USED WITH LUBRICATED BUSHING)	PLUG-013NSH-230		1	STEEL
	FITTING, GREASE PIN (1/8" NPT) (USED WITH NON-LUBRICATED BUSHING)	GRSF-013NST-230		1	STEEL
B6	SCREWS (7/16"-14 X 1-1/8"), BRACKET	S01C438A12WA2A2		8	STEEL
B7	GASKET, BRACKET	0240-2900-950		1	INTERFACE TS-9003
B8	BRACKET	0240-2100-130		1	CARBON STEEL
C1	CASE, 2" ANSI KIT (INCLUDES B6, B7, C2, F4, F5)	0240-3001-130		1	CARBON STEEL
C2	PLUG, PIPE (1/4" NPT)	PLUG-025NSH-230		2	STEEL
D1	ROTOR, ASSEMBLY (A/B/C CLEARANCE)	0240-4000-130	N/A	1	CARBON STEEL/STEEL
		N/A	0320-4000-130	1	CARBON STEEL/STEEL
	ROTOR, ASSEMBLY (D CLEARANCE)	0240-4003-130	N/A	1	CARBON STEEL/STEEL
		N/A	0320-4003-130	1	CARBON STEEL/STEEL
E1	GEAR, IDLER ASSEMBLY	0240-5000-110	0320-5000-110	1	CAST IRON/CARBON GRAPHITE
		0240-5010-110	0320-5010-110	1	CAST IRON/BRONZE
E2	BUSHING, IDLER	0240-5800-300	0320-5800-300	1	CARBON GRAPHITE
		0240-5800-320	0320-5800-320	1	BRONZE
F1	HEAD, KIT (INCLUDES F2 THRU F5)	0240-6010-130	0320-6010-130	1	CARBON STEEL/STEEL
F2	PIN, IDLER	0240-6200-231	0320-6200-231	1	HARDENED STEEL
F3	PLUG, PIPE (1/8" NPT) (USED WITH LUBRICATED BUSHING)	N/A	PLUG-013NSH-230	1	STEEL
	FITTING, GREASE PIN (1/8" NPT) (USED WITH NON-LUBRICATED BUSHING)		GRSF-013NST-230	1	STEEL
F4	CAPSCREW (7/16"-14 X 1-1/8"), HEAD	S01C438A12WA2A2		6	STEEL
F5	GASKET, HEAD	0240-6900-950		1	INTERFACE TS-9003
G1	VALVE, COVER ASSEMBLY (INCLUDES G2, G13 AND G14)	0240-7000-230		1	STAINLESS STEEL/STEEL
	VALVE, ASSEMBLY-50 PSI (INCLUDES G2 THRU G14)	0240-7001-130		1	CARBON STEEL
	VALVE, ASSEMBLY-80 PSI (INCLUDES G2 THRU G14)	0240-7002-130		1	CARBON STEEL
	VALVE, ASSEMBLY-150 PSI (INCLUDES G2 THRU G14)	0240-7003-130		1	CARBON STEEL
	VALVE, ASSEMBLY-200 PSI (INCLUDES G2 THRU G14)	0240-7004-130		1	CARBON STEEL
G2	VALVE, BODY	0240-7100-130		1	CARBON STEEL
	VALVE, COVER (NOT SHOWN)	0240-7101-250		2	STAINLESS STEEL
G3	VALVE, GASKET BONNET	0240-7910-951		1	KLINGERSIL® C-4401
G4	VALVE, BONNET	0240-7200-130		1	CARBON STEEL
G5	VALVE, GASKET CAP	0240-7920-951		1	KLINGERSIL® C-4401
G6	VALVE, CAP	0240-7300-110		1	CAST IRON
G7	VALVE, ADJUSTMENT SCREW	0240-7700-230		1	STEEL
G8	VALVE, LOCK NUT	0240-7710-230		1	STEEL
G9	VALVE, SPRING GUIDE	0240-7500-230		1	STEEL
G10	VALVE, SPRING LARGE (USED WITH 150 & 200 PSI VALVES)	0240-7602-250		1	STAINLESS STEEL
G11	VALVE, SPRING SMALL (USED WITH 50 PSI VALVES)	0240-7600-250		1	STAINLESS STEEL
	VALVE, SPRING SMALL (USED WITH 80 & 200 PSI VALVES)	0240-7601-250		1	STAINLESS STEEL
G12	VALVE, POPPET	0240-7400-110		1	CAST IRON
G13	CAPSCREW (5/16"-18 X .625), VALVE	S01C312625WA2A2		8	STEEL
G14	GASKET, VALVE	0240-7900-950		2	INTERFACE TS-9003
H1	GLAND, PACKING	0240-8200-110		1	CAST IRON
	GLAND, PACKING (TYPE 9)	0240-8201-110		1	CAST IRON
H2	NUT (7/16"-14), PACKING GLAND	N04C438375WA2A2		2	STEEL
H3	CAPSCREW (7/16"-14), PACKING GLAND	S01C438B50CLOA1		2	STAINLESS STEEL
	TYPE 1, COMPONENT SEAL	0240-8000-900		1	BUNA-N
	TYPE 9, COMPONENT SEAL	0240-8001-920		1	PTFE
H4	COLLAR, MECHANICAL SEAL ASSEMBLY	0240-8050-230		1	STEEL
H5	PACKING, KIT (INCLUDES H7)	0240-8100-925K		1	PTFE - GRAPHITE
H6	WASHER, PACKING RETAINING	0240-8150-230		1	STEEL

**G1-55\_69**

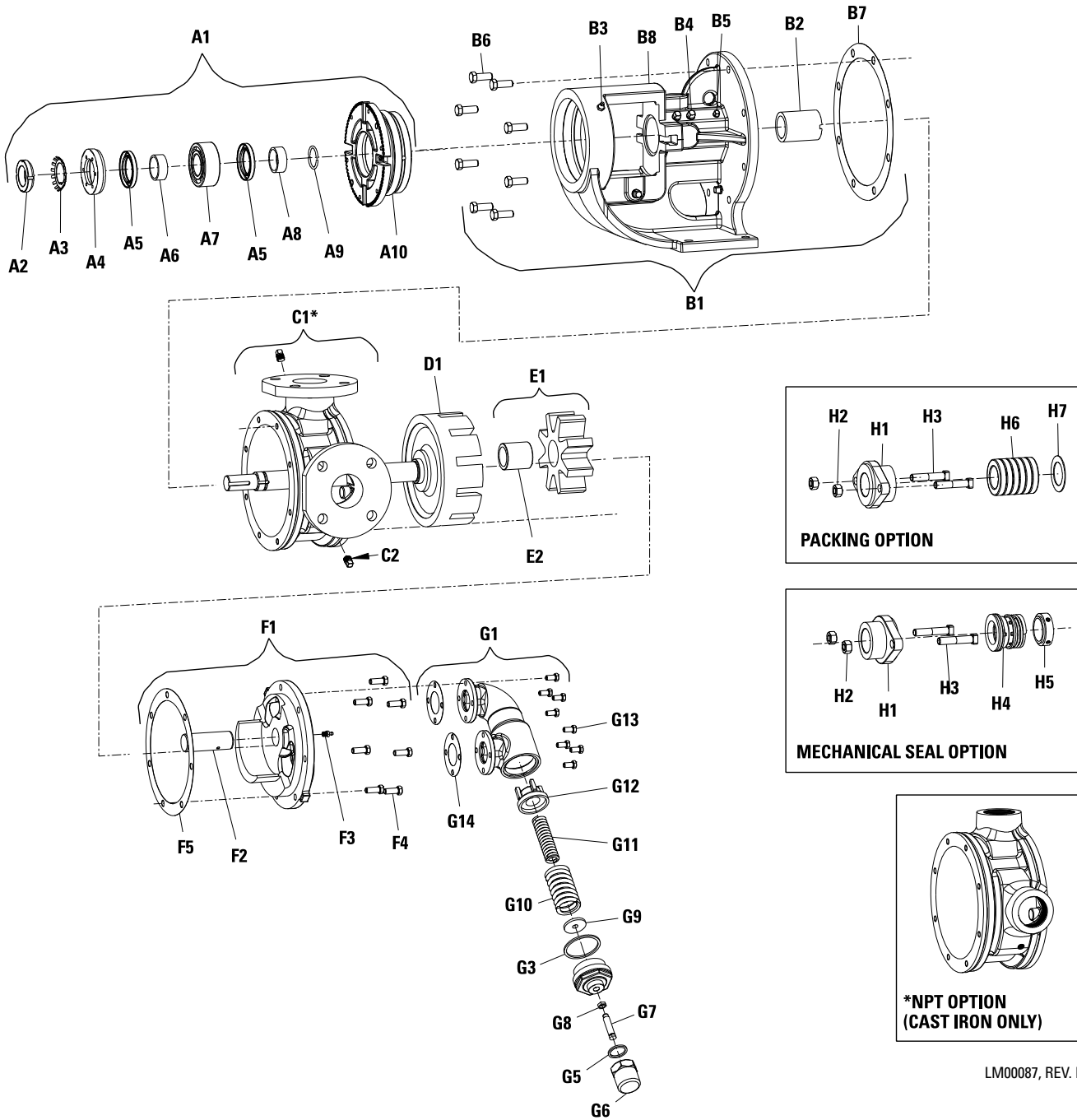

Item	Description	G1-55	G1-69	Qty.	Material
A1	HOUSING, BEARING ASSEMBLY (INCLUDES A2 THRU A13)	0240-1000-110		1	CAST IRON
A2	LOCKNUT, SHAFT	0240-1710-230		1	STEEL
A3	LOCKWASHER, SHAFT	0240-1720-230		1	STEEL
A4	ENDCAP, BEARING HOUSING	0240-1200-230		1	STEEL
A5	LIP SEAL, BEARING HOUSING	0240-1900-900		2	BUNA-N
A6	COLLAR, OUTER BEARING SPACER	0240-1300-230		1	STEEL
A7	BEARING	0240-1400-230		1	STEEL
A8	COLLAR, INNER BEARING SPACER	0240-1301-230		1	STEEL
A9	SEMI-ROUND RINGS	0240-1310-230		2	STEEL
A10	HOUSING, BEARING	0240-1100-110		1	CAST IRON
A11	SET SCREW (3/8"-16 X 1/2"), BEARING HOUSING (NOT SHOWN)	S57U375500WA6L7		2	STEEL
A12	SET SCREW (5/16"-18 X 5/16"), END CAP (NOT SHOWN)	S57U313313WA6L7		2	STEEL
A13	INSERT, BEARING HOUSING (NOT SHOWN)	0020-1790-400		2	NYLON
B1	BRACKET, ASSEMBLY (INCLUDES B2 THRU B8)	0550-2000-110		1	CAST IRON/CARBON GRAPHITE
		0550-2010-110		1	CAST IRON/BRONZE
B2	BUSHING, BRACKET	0240-2800-300		1	CARBON GRAPHITE
		0240-2800-320		1	BRONZE
B3	FITTING, GREASE (1/8" NPT)	GRSF-013NST-230		1	STEEL
B4	PLUG, PIPE (1/4" NPT)	PLUG-025NSH-230		3	STEEL
B5	PLUG, PIPE (1/8" NPT) (USED WITH LUBRICATED BUSHING)	PLUG-013NSH-230		1	STEEL
	FITTING, GREASE PIN (1/8" NPT) (USED WITH NON-LUBRICATED BUSHING)	GRSF-013NST-230		1	STEEL
B6	SCREWS (7/16"-14 X 1-1/8"), BRACKET	S01C438A12WA2A2		8	STEEL
B7	GASKET, BRACKET	0550-2900-950		1	INTERFACE TS-9003
B8	BRACKET	0550-2100-110		1	CAST IRON
C1	CASE, 2" NPT KIT (INCLUDES B6, B7, C2, F4, F5)	0550-3000-110	N/A	1	CAST IRON
C1	CASE, 2.5" ANSI KIT (INCLUDES B6, B7, C2, F4, F5)	0550-3001-110	N/A	1	CAST IRON
C1	CASE, 3" ANSI KIT (INCLUDES B6, B7, C2, F4, F5)	N/A	0690-3001-110	1	CAST IRON
C2	PLUG, PIPE (1/4" NPT)	PLUG-025NSH-230	PLUG-025NSH-230	2	STEEL
D1	ROTOR, ASSEMBLY (A/B CLEARANCE)	0550-4000-110	0690-4000-110	1	CAST IRON/STEEL
	ROTOR, ASSEMBLY (C CLEARANCE)	0550-4002-110	0690-4002-110	1	CAST IRON/STEEL
	ROTOR, ASSEMBLY (D CLEARANCE)	0550-4003-110	0690-4003-110	1	CAST IRON/STEEL
	ROTOR, ASSEMBLY (E CLEARANCE)	0550-4004-110	0690-4004-110	1	CAST IRON/STEEL
		0550-4004-130	0690-4004-130	1	STEEL
	ROTOR, ASSEMBLY (F CLEARANCE)	0550-4005-130	0690-4005-130	1	STEEL
E1	GEAR, IDLER ASSEMBLY	0550-5000-110	0690-5000-110	1	CAST IRON/CARBON GRAPHITE
		0550-5010-110	0690-5010-110	1	CAST IRON/BRONZE
E2	BUSHING, IDLER	0550-5800-300	0690-5800-300	1	CARBON GRAPHITE
		0550-5800-320	0690-5800-320	1	BRONZE
F1	HEAD, ASSEMBLY KIT	0550-6010-110	0690-6010-110	1	CAST IRON/STEEL
F2	PIN, IDLER	0550-6200-231	0690-6200-231	1	HARDENED STEEL
F3	PLUG, PIPE (1/8" NPT) (USED WITH LUBRICATED BUSHING)		PLUG-013NSH-230	1	STEEL
F3	FITTING, GREASE PIN (1/8" NPT) (USED WITH NON-LUBRICATED BUSHING)		GRSF-013NST-230	1	STEEL
F4	CAPSCREW (7/16"-14 X 1-1/8"), HEAD		S01C438A12WA2A2	7	STEEL
F5	GASKET, HEAD	0550-6900-950		1	INTERFACE TS-9003
	VALVE, COVER ASSEMBLY (INCLUDES G2, G13 AND G14)	0550-7000-230		1	STAINLESS STEEL/STEEL
	VALVE, ASSEMBLY-60 PSI (INCLUDES G2 THRU G14)	0550-7001-110		1	CAST IRON
	VALVE, ASSEMBLY-90 PSI (INCLUDES G2 THRU G14)	0550-7002-110		1	CAST IRON
	VALVE, ASSEMBLY-160 PSI (INCLUDES G2 THRU G14)	0550-7003-110		1	CAST IRON
	VALVE, ASSEMBLY-200 PSI (INCLUDES G2 THRU G14)	0550-7004-110		1	CAST IRON
G2	VALVE, BODY	0550-7100-110		1	CAST IRON
	VALVE, COVER (NOT SHOWN)	0550-7101-250		2	STAINLESS STEEL
G3	VALVE, GASKET BONNET	0240-7910-951		1	KLINGERSIL® C-4401
G4	VALVE, BONNET	0240-7200-110		1	CAST IRON
G5	VALVE, GASKET CAP	0240-7920-951		1	KLINGERSIL® C-4401
G6	VALVE, CAP	0240-7300-110		1	CAST IRON
G7	VALVE, ADJUSTMENT SCREW	0240-7700-230		1	STEEL
G8	VALVE, LOCK NUT	0240-7710-230		1	STEEL
G9	VALVE, SPRING GUIDE	0240-7500-230		1	STEEL
G10	VALVE, SPRING LARGE (USED WITH 160 & 200 PSI VALVES)	0240-7602-250		1	STAINLESS STEEL
	VALVE, SPRING SMALL (USED WITH 60 PSI VALVES)	0240-7600-250		1	STAINLESS STEEL
G11	VALVE, SPRING SMALL (USED WITH 90 & 200 PSI VALVES)	0240-7601-250		1	STAINLESS STEEL
		0240-7400-110		1	CAST IRON
G12	VALVE, POPPET	0240-7400-110		1	CAST IRON
G13	CAPSCREW (3/8"-16 X 3/4"), VALVE	S01C375750WA2A2		8	STEEL
G14	GASKET, VALVE	0550-7900-950		2	INTERFACE TS-9003
H1	GLAND, PACKING	0240-8200-110		1	CAST IRON
	GLAND, PACKING (TYPE 9)	0240-8201-110		1	CAST IRON
H2	NUT (7/16"-14), PACKING GLAND	N04C438375WA2A2		2	STEEL
H3	CAPSCREW (7/16"-14), PACKING GLAND	S01C438B50CLOA1		2	STAINLESS STEEL
H4	TYPE 1, COMPONENT SEAL	0240-8000-900		1	BUNA-N
	TYPE 1, COMPONENT SEAL	0240-8000-910		1	VITON
	TYPE 9, COMPONENT SEAL	0240-8001-920		1	PTFE
H5	COLLAR, MECHANICAL SEAL ASSEMBLY	0240-8050-230		1	STEEL
H6	PACKING, KIT (INCLUDES H7)	0240-8100-925K		1	PTFE - GRAPHITE
H7	WASHER, PACKING RETAINING	0240-8150-230		1	STEEL

Item	Description	G1-55	G1-69	Qty.	Material
A1	HOUSING, BEARING ASSEMBLY (INCLUDES A2 THRU A13)	0240-1000-110		1	CAST IRON
A2	LOCKNUT, SHAFT	0240-1710-230		1	STEEL
A3	LOCKWASHER, SHAFT	0240-1720-230		1	STEEL
A4	ENDCAP, BEARING HOUSING	0240-1200-230		1	STEEL
A5	LIP SEAL, BEARING HOUSING	0240-1900-900		2	BUNA-N
A6	COLLAR, OUTER BEARING SPACER	0240-1300-230		1	STEEL
A7	BEARING	0240-1400-230		1	STEEL
A8	COLLAR, INNER BEARING SPACER	0240-1301-230		1	STEEL
A9	SEMI-ROUND RINGS	0240-1310-230		2	STEEL
A10	HOUSING, BEARING	0240-1100-110		1	CAST IRON
A11	SET SCREW (3/8"-16 X 1/2"), BEARING HOUSING (NOT SHOWN)	S57U375500WA6L7		2	STEEL
A12	SET SCREW (5/16"-18 X 5/16"), END CAP (NOT SHOWN)	S57U313313WA6L7		2	STEEL
A13	INSERT, BEARING HOUSING (NOT SHOWN)	0020-1790-400		2	NYLON
B1	BRACKET, ASSEMBLY (INCLUDES B2 THRU B8)	0550-2000-150		1	STAINLESS STEEL/CARBON GRAPHITE
B2	BUSHING, BRACKET	0240-2800-300		1	CARBON GRAPHITE
B3	FITTING, GREASE (1/8" NPT)	GRSF-013NST-230		1	STEEL
B4	PLUG, PIPE (1/4" NPT)	PLUG-025NSH-250		3	STAINLESS STEEL
B5	PLUG, PIPE (1/8" NPT)	PLUG-013NSH-250		1	STAINLESS STEEL
B6	SCREWS (7/16"-14 X 1-1/8"), BRACKET	S01C438A12AA9A1		8	STAINLESS STEEL
B7	GASKET, BRACKET	0550-2900-950		1	INTERFACE TS-9003
B8	BRACKET	0550-2100-150		1	STAINLESS STEEL
C1	CASE, 2.5" ANSI KIT (INCLUDES B6, B7, C2, F4, F5)	0550-3001-150	N/A	1	STAINLESS STEEL
C1	CASE, 3" ANSI KIT (INCLUDES B6, B7, C2, F4, F5)	N/A	0690-3001-150	1	STAINLESS STEEL
C2	PLUG, PIPE (1/4" NPT)	PLUG-025NSH-250	PLUG-025NSH-250	2	STAINLESS STEEL
D1	ROTOR, ASSEMBLY (A CLEARANCE)	0550-4000-155	0690-4000-155	1	STAINLESS STEEL
		0550-4000-176	0690-4000-176	1	NITRONIC 60/STAINLESS STEEL
	ROTOR, ASSEMBLY (B/C CLEARANCE)	0550-4002-155	0690-4002-155	1	STAINLESS STEEL
		0550-4002-176	0690-4002-176	1	NITRONIC 60/STAINLESS STEEL
	ROTOR, ASSEMBLY (D CLEARANCE)	0550-4003-155	0690-4003-155	1	STAINLESS STEEL
ROTOR, ASSEMBLY (E CLEARANCE)	0550-4003-176	0690-4003-176	1	NITRONIC 60/STAINLESS STEEL	
E1	GEAR, IDLER ASSEMBLY	0550-4004-110	N/A	1	CAST IRON/STEEL
		0550-5000-255	0690-5000-255	1	STAINLESS STEEL/CARBON GRAPHITE
E2	BUSHING, IDLER	0550-5000-276	0690-5000-276	1	NITRONIC 60/CARBON GRAPHITE
F1	HEAD, KIT (INCLUDES F2, F4, F5)	0550-5801-300	0690-5801-300	1	CARBON GRAPHITE
F2	PIN, IDLER	0550-6010-150	0690-6010-150	1	STAINLESS/HARDENED STAINLESS
F4	PIN, IDLER	0550-6200-254	0690-6200-254	1	HARDENED STAINLESS STEEL
F4	CAPSCREW (7/16"-14 X 1-1/8"), HEAD	S01C438A12AA9A1		7	STAINLESS STEEL
F5	GASKET, HEAD	0550-6900-950		1	INTERFACE TS-9003
G1	VALVE, COVER ASSEMBLY (INCLUDES G2, G13 AND G14)	0550-7000-250		1	STAINLESS STEEL/STAINLESS STEEL
	VALVE, ASSEMBLY-60 PSI (INCLUDES G2 THRU G14)	0550-7001-150		1	STAINLESS STEEL
	VALVE, ASSEMBLY-90 PSI (INCLUDES G2 THRU G14)	0550-7002-150		1	STAINLESS STEEL
	VALVE, ASSEMBLY-150 PSI (INCLUDES G2 THRU G14)	0550-7003-150		1	STAINLESS STEEL
G2	VALVE, BODY	0550-7100-150		1	STAINLESS STEEL
	VALVE, COVER (NOT SHOWN)	0550-7101-250		2	STAINLESS STEEL
G3	VALVE, GASKET BONNET	0240-7910-951		1	KLINGERSIL® C-4401
G4	VALVE, BONNET	0240-7200-150		1	STAINLESS STEEL
G5	VALVE, GASKET CAP	0240-7920-951		1	KLINGERSIL® C-4401
G6	VALVE, CAP	0240-7300-150		1	STAINLESS STEEL
G7	VALVE, ADJUSTMENT SCREW	0240-7700-255		1	STAINLESS STEEL
G8	VALVE, LOCK NUT	0240-7710-255		1	STAINLESS STEEL
G9	VALVE, SPRING GUIDE	0240-7500-250		1	STAINLESS STEEL
G10	VALVE, SPRING LARGE (USED WITH 160 & 200 PSI VALVES)	0240-7602-250		1	STAINLESS STEEL
G11	VALVE, SPRING SMALL (USED WITH 60 PSI VALVES)	0240-7600-250		1	STAINLESS STEEL
	VALVE, SPRING SMALL (USED WITH 90 & 200 PSI VALVES)	0240-7601-250		1	STAINLESS STEEL
G12	VALVE, POPPET	0240-7400-150		1	STAINLESS STEEL
G13	CAPSCREW (3/8"-16 X 3/4"), VALVE	S01C375750AA9A1		8	STAINLESS STEEL
G14	GASKET, VALVE	0550-7900-950		2	INTERFACE TS-9003
H1	GLAND, PACKING (TYPE 9)	0240-8201-150		1	STAINLESS STEEL
H2	NUT (7/16"-14), PACKING GLAND	N04C438375AA9A1		2	STAINLESS STEEL
H3	CAPSCREW (7/16"-14), PACKING GLAND	S01C438B50CLOA1		2	STAINLESS STEEL
H4	TYPE 9, COMPONENT SEAL	0240-8001-920		1	PTFE
H6	PACKING, KIT (INCLUDES H7)	0240-8100-925K		1	PTFE - GRAPHITE
H7	WASHER, PACKING RETAINING	0240-8150-250		1	STAINLESS STEEL

Item	Description	G1-55	G1-69	Qty.	Material
A1	HOUSING, BEARING ASSEMBLY (INCLUDES A2 THRU A13)	0240-1000-110		1	CAST IRON
A2	LOCKNUT, SHAFT	0240-1710-230		1	STEEL
A3	LOCKWASHER, SHAFT	0240-1720-230		1	STEEL
A4	ENDCAP, BEARING HOUSING	0240-1200-230		1	STEEL
A5	LIP SEAL, BEARING HOUSING	0240-1900-900		2	BUNA-N
A6	COLLAR, OUTER BEARING SPACER	0240-1300-230		1	STEEL
A7	BEARING	0240-1400-230		1	STEEL
A8	COLLAR, INNER BEARING SPACER	0240-1301-230		1	STEEL
A9	SEMI-ROUND RINGS	0240-1310-230		2	STEEL
A10	HOUSING, BEARING	0240-1100-110		1	CAST IRON
A11	SET SCREW (3/8"-16 X 1/2"), BEARING HOUSING (NOT SHOWN)	S57U375500WA6L7		2	STEEL
A12	SET SCREW (5/16"-18 X 5/16"), END CAP (NOT SHOWN)	S57U313313WA6L7		2	STEEL
A13	INSERT, BEARING HOUSING (NOT SHOWN)	0020-1790-400		2	NYLON
B1	BRACKET, ASSEMBLY (INCLUDES B2 THRU B8)	0550-2000-130		1	CARBON STEEL/CARBON GRAPHITE
		0550-2010-130		1	CARBON STEEL/BRONZE
B2	BUSHING, BRACKET	0240-2800-300		1	CARBON GRAPHITE
		0240-2800-320		1	BRONZE
B3	FITTING, GREASE (1/8" NPT)	GRSF-013NST-230		1	STEEL
B4	PLUG, PIPE (1/4" NPT)	PLUG-025NSH-230		3	STEEL
B5	PLUG, PIPE (1/8" NPT) (USED WITH LUBRICATED BUSHING)	PLUG-013NSH-230		1	STEEL
	FITTING, GREASE PIN (1/8" NPT) (USED WITH NON-LUBRICATED BUSHING)	GRSF-013NST-230		1	STEEL
B6	SCREWS (7/16"-14 X 1-1/8"), BRACKET	S01C438A12WA2A2		8	STEEL
B7	GASKET, BRACKET	0550-2900-950		1	INTERFACE TS-9003
B8	BRACKET	0550-2100-130		1	CARBON STEEL
C1	CASE, 2.5" ANSI KIT (INCLUDES B6, B7, C2, F4, F5)	0550-3001-130	N/A	1	CARBON STEEL
	CASE, 3" ANSI KIT (INCLUDES B6, B7, C2, F4, F5)	N/A	0690-3001-130	1	CARBON STEEL
C2	PLUG, PIPE (1/4" NPT)	PLUG-025NSH-230	PLUG-025NSH-230	2	STEEL
D1	ROTOR, ASSEMBLY (A/B/C CLEARANCE)	0550-4000-130	0690-4000-130	1	CARBON STEEL/STEEL
	ROTOR, ASSEMBLY (D CLEARANCE)	0550-4003-130	0690-4003-130	1	CARBON STEEL/STEEL
	ROTOR, ASSEMBLY (E CLEARANCE)	0550-4004-110	0690-4004-110	1	CARBON STEEL/STEEL
		0550-4004-130	0690-4004-130	1	STEEL
	ROTOR, ASSEMBLY (F CLEARANCE)	0550-4005-130	0690-4005-130	1	STEEL
E1	GEAR, IDLER ASSEMBLY	0550-5000-110	0690-5000-110	1	CAST IRON/CARBON GRAPHITE
		0550-5010-110	0690-5010-110	1	CAST IRON/BRONZE
E2	BUSHING, IDLER	0550-5800-300	0690-5800-300	1	CARBON GRAPHITE
		0550-5800-320	0690-5800-320	1	BRONZE
F1	HEAD, ASSEMBLY KIT	0550-6010-130	0690-6010-130	1	CARBON STEEL/STEEL
F2	PIN, IDLER	0550-6200-231	0690-6200-231	1	HARDENED STEEL
F3	PLUG, PIPE (1/8" NPT) (USED WITH LUBRICATED BUSHING)	PLUG-013NSH-230		1	STEEL
	FITTING, GREASE PIN (1/8" NPT) (USED WITH NON-LUBRICATED BUSHING)	GRSF-013NST-230		1	STEEL
F4	CAPSCREW (7/16"-14 X 1-1/8"), HEAD	S01C438A12WA2A2		7	STEEL
F5	GASKET, HEAD	0550-6900-950		1	INTERFACE TS-9003
G1	VALVE, COVER ASSEMBLY (INCLUDES G2, G13 AND G14)	0550-7000-230		1	STAINLESS STEEL/STEEL
	VALVE, ASSEMBLY-60 PSI (INCLUDES G2 THRU G14)	0550-7001-130		1	CARBON STEEL
	VALVE, ASSEMBLY-90 PSI (INCLUDES G2 THRU G14)	0550-7002-130		1	CARBON STEEL
	VALVE, ASSEMBLY-160 PSI (INCLUDES G2 THRU G14)	0550-7003-130		1	CARBON STEEL
	VALVE, ASSEMBLY-200 PSI (INCLUDES G2 THRU G14)	0550-7004-130		1	CARBON STEEL
G2	VALVE, BODY	0550-7100-130		1	CARBON STEEL
	VALVE, COVER (NOT SHOWN)	0550-7101-250		2	STAINLESS STEEL
G3	VALVE, GASKET BONNET	0240-7910-951		1	KLINGERSIL® C-4401
G4	VALVE, BONNET	0240-7200-130		1	CARBON STEEL
G5	VALVE, GASKET CAP	0240-7920-951		1	KLINGERSIL® C-4401
G6	VALVE, CAP	0240-7300-110		1	CAST IRON
G7	VALVE, ADJUSTMENT SCREW	0240-7700-230		1	STEEL
G8	VALVE, LOCK NUT	0240-7710-230		1	STEEL
G9	VALVE, SPRING GUIDE	0240-7500-230		1	STEEL
G10	VALVE, SPRING LARGE (USED WITH 160 & 200 PSI VALVES)	0240-7602-250		1	STAINLESS STEEL
	VALVE, SPRING SMALL (USED WITH 60 PSI VALVES)	0240-7600-250		1	STAINLESS STEEL
G11	VALVE, SPRING SMALL (USED WITH 90 & 200 PSI VALVES)	0240-7601-250		1	STAINLESS STEEL
	VALVE, POPPET	0240-7400-110		1	CAST IRON
G12	CAPSCREW (3/8"-16 X 3/4"), VALVE	S01C375750WA2A2		8	STEEL
G14	GASKET, VALVE	0550-7900-950		2	INTERFACE TS-9003
H1	GLAND, PACKING	0240-8200-110		1	CAST IRON
	GLAND, PACKING (TYPE 9)	0240-8201-110		1	CAST IRON
H2	NUT (7/16"-14), PACKING GLAND	N04C438375WA2A2		2	STEEL
H3	CAPSCREW (7/16"-14), PACKING GLAND	S01C438B50CLOA1		2	STAINLESS STEEL
H4	TYPE 1, COMPONENT SEAL	0240-8000-900		1	BUNA-N
	TYPE 1, COMPONENT SEAL	0240-8000-910		1	VITON
	TYPE 9, COMPONENT SEAL	0240-8001-920		1	PTFE
H5	COLLAR, MECHANICAL SEAL ASSEMBLY	0240-8050-230		1	STEEL
H6	PACKING, KIT (INCLUDES H7)	0240-8100-925K		1	PTFE - GRAPHITE
H7	WASHER, PACKING RETAINING	0240-8150-230		1	STEEL

**G1-82**

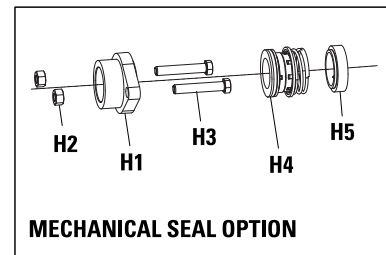
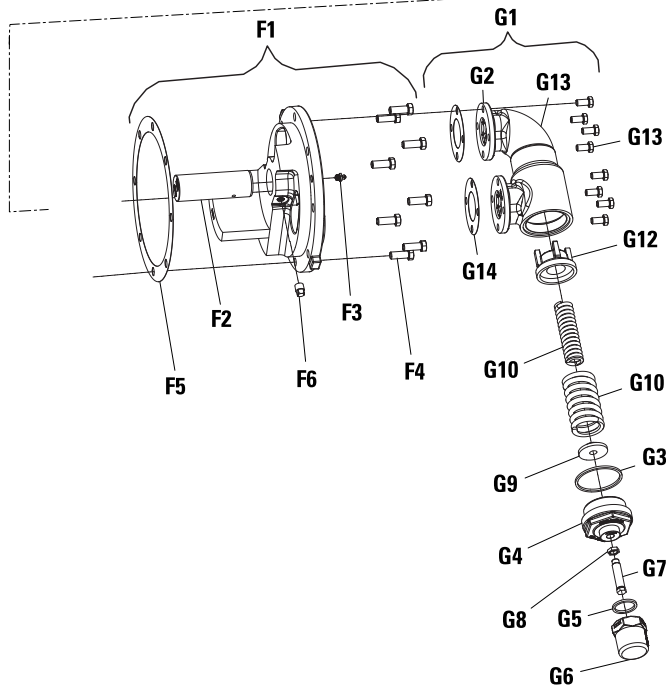
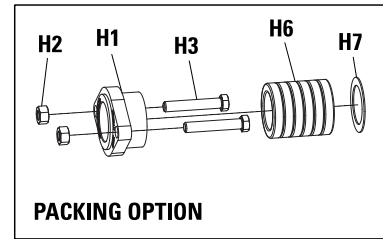
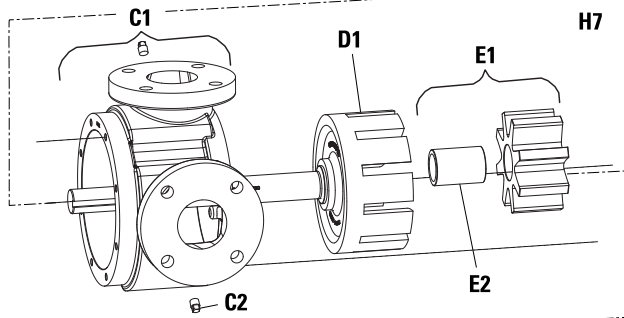
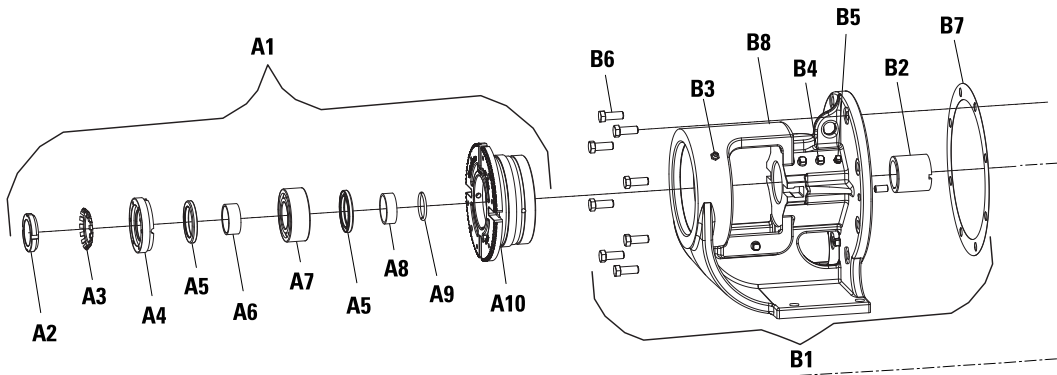

LM0025, REV. A

Item	Description	G1-82	Qty.	Material
A1	HOUSING, BEARING ASSEMBLY (INCLUDES A2 THRU A13)	0820-1000-110	1	CAST IRON
A2	LOCKNUT, SHAFT	0820-1710-230	1	STEEL
A3	LOCKWASHER, SHAFT	0820-1720-230	1	STEEL
A4	ENDCAP, BEARING HOUSING	0820-1200-230	1	STEEL
A5	LIP SEAL, BEARING HOUSING	0820-1900-900	2	BUNA-N
A6	COLLAR, OUTER BEARING SPACER	0820-1300-230	1	STEEL
A7	BEARING	0820-1400-230	1	STEEL
A8	COLLAR, INNER BEARING SPACER	0820-1301-230	1	STEEL
A9	SEMI-ROUND RINGS	0820-1310-230	2	STEEL
A10	HOUSING, BEARING	0820-1100-110	1	CAST IRON
A11	SET SCREW (3/8"-16 X 1/2"), BEARING HOUSING (NOT SHOWN)	S57U375500WA6L7	2	STEEL
A12	SET SCREW (5/16"-18 X 5/16"), END CAP (NOT SHOWN)	S57U313313WA6L7	2	STEEL
A13	INSERT, BEARING HOUSING (NOT SHOWN)	0020-1790-400	2	NYLON
B1	BRACKET, ASSEMBLY (INCLUDES B2 THRU B8)	0820-2000-110	1	CAST IRON/CARBON GRAPHITE
		0820-2010-110	1	CAST IRON/BRONZE
B2	BUSHING, BRACKET	0820-2800-300	1	CARBON GRAPHITE
		0820-2800-320	1	BRONZE
B3	FITTING, GREASE (1/8" NPT)	GRSF-013NST-230	1	STEEL
B4	PLUG, PIPE (1/4" NPT)	PLUG-025NSH-230	3	STEEL
B5	PLUG, PIPE (1/8" NPT) (USED WITH LUBRICATED BUSHING)	PLUG-013NSH-230	1	STEEL
	FITTING, GREASE (1/8" NPT) (USED WITH NON-LUBRICATED BUSHING)	GRSF-013NST-230	1	STEEL
B6	SCREWS (7/16"-14 X 1-1/4"), BRACKET	S01C438A25WA2A8	8	STEEL
B7	GASKET, BRACKET	0550-2900-950	1	INTERFACE TS-9003
B8	BRACKET	0820-2100-110	1	CAST IRON
C1	CASE, 3" ANSI KIT (INCLUDES B6, B7, C2, F4, F5)	0820-3001-110	1	CAST IRON
C2	PLUG, PIPE (1/4" NPT)	PLUG-025NSH-230	2	STEEL
D1	ROTOR, ASSEMBLY (A/B CLEARANCE)	0820-4000-121	1	DUCTILE IRON/STEEL
	ROTOR, ASSEMBLY (C CLEARANCE)	0820-4002-121	1	DUCTILE IRON/STEEL
	ROTOR, ASSEMBLY (D CLEARANCE)	0820-4003-121	1	DUCTILE IRON/STEEL
	ROTOR, ASSEMBLY (E CLEARANCE)	0820-4004-121	1	DUCTILE IRON/STEEL
E1	GEAR, IDLER ASSEMBLY	0820-5000-110	1	CAST IRON/CARBON GRAPHITE
		0820-5010-110	1	CAST IRON/BRONZE
E2	BUSHING, IDLER	0820-5800-300	1	CARBON GRAPHITE
		0820-5800-320	1	BRONZE
F1	HEAD, ASSEMBLY KIT (F2 THRU F6)	0820-6010-110	1	CAST IRON/STEEL
F2	PIN, IDLER	0820-6200-231	1	HARDENED STEEL
F3	PLUG, PIPE (1/8" NPT) (USED WITH LUBRICATED BUSHING)	PLUG-013NSH-230	1	STEEL
	FITTING, GREASE PIN (1/8" NPT) (USED WITH NON-LUBRICATED BUSHING)	GRSF-013NST-230	1	STEEL
F4	CAPSCREW (7/16"-14 X 1-1/4"), HEAD	S01C438A25WA2A8	8	STEEL
F5	GASKET, HEAD	0550-2900-950	1	INTERFACE TS-9003
F6	PLUG, PIPE (1/4" NPT)	PLUG-025NSH-230	1	STEEL
G1	VALVE, COVER ASSEMBLY (INCLUDES G2, G13 AND G14)	0550-7000-230	1	STAINLESS STEEL/STEEL
	VALVE, ASSEMBLY-60 PSI (INCLUDES G2 THRU G9, G11 THRU G14)	0550-7001-110	1	CAST IRON
	VALVE, ASSEMBLY-90 PSI (INCLUDES G2 THRU G9, G11 THRU G14)	0550-7002-110	1	CAST IRON
	VALVE, ASSEMBLY-160 PSI (INCLUDES G2 THRU G10, G12 THRU G14)	0550-7003-110	1	CAST IRON
	VALVE, ASSEMBLY-200 PSI (INCLUDES G2 THRU G14)	0550-7004-110	1	CAST IRON
G2	VALVE, BODY	0550-7100-110	1	CAST IRON
	VALVE, COVER (NOT SHOWN)	0550-7101-250	2	STAINLESS STEEL
G3	VALVE, GASKET BONNET	0240-7910-951	1	KLINGERSIL® C-4401
G4	VALVE, BONNET	0240-7200-110	1	CAST IRON
G5	VALVE, GASKET CAP	0240-7920-951	1	KLINGERSIL® C-4401
G6	VALVE, CAP	0240-7300-110	1	CAST IRON
G7	VALVE, ADJUSTMENT SCREW	0240-7700-230	1	STEEL
G8	VALVE, LOCK NUT	0240-7710-230	1	STEEL
G9	VALVE, SPRING GUIDE	0240-7500-230	1	STEEL
G10	VALVE, SPRING LARGE (USED WITH 160 & 200 PSI VALVES)	0240-7602-250	1	STAINLESS STEEL
G11	VALVE, SPRING SMALL (USED WITH 60 PSI VALVES)	0240-7600-250	1	STAINLESS STEEL
	VALVE, SPRING SMALL (USED WITH 90 & 200 PSI VALVES)	0240-7601-250	1	STAINLESS STEEL
G12	VALVE, POPPET	0240-7400-110	1	CAST IRON
G13	CAPSCREW (3/8"-16 X 3/4"), VALVE	S01C375750WA2A2	8	STEEL
G14	GASKET, VALVE	0550-7900-950	2	INTERFACE TS-9003
H1	GLAND, PACKING (TYPE 1)	0820-8200-150	1	STAINLESS STEEL
	GLAND, PACKING (TYPE 9)	0820-8201-150	1	STAINLESS STEEL
H2	NUT (7/16"-14), PACKING GLAND	N04C438375AA9A1	2	STAINLESS STEEL
H3	CAPSCREW (7/16"-14), PACKING GLAND	S01C438B50CLOA1	2	STAINLESS STEEL
H4	TYPE 1, COMPONENT SEAL	0820-8000-910	1	VITON
	TYPE 9, COMPONENT SEAL	0820-8001-920	1	PTFE/Ni-RESIST
H5	COLLAR, MECHANICAL SEAL ASSEMBLY	0820-8050-250	1	STAINLESS STEEL
H6	PACKING, KIT (INCLUDES H7)	0820-8100-925K	1	PTFE - GRAPHITE
H7	WASHER, PACKING RETAINING	0820-8150-250	1	STAINLESS STEEL

Item	Description	G1-82	Qty.	Material
A1	HOUSING, BEARING ASSEMBLY (INCLUDES A2 THRU A13)	0820-1000-110	1	CAST IRON
A2	LOCKNUT, SHAFT	0820-1710-230	1	STEEL
A3	LOCKWASHER, SHAFT	0820-1720-230	1	STEEL
A4	ENDCAP, BEARING HOUSING	0820-1200-230	1	STEEL
A5	LIP SEAL, BEARING HOUSING	0820-1900-900	2	BUNA-N
A6	COLLAR, OUTER BEARING SPACER	0820-1300-230	1	STEEL
A7	BEARING	0820-1400-230	1	STEEL
A8	COLLAR, INNER BEARING SPACER	0820-1301-230	1	STEEL
A9	SEMI-ROUND RINGS	0820-1310-230	2	STEEL
A10	HOUSING, BEARING	0820-1100-110	1	CAST IRON
A11	SET SCREW (3/8"-16 X 1/2"), BEARING HOUSING (NOT SHOWN)	S57U375500WA6L7	2	STEEL
A12	SET SCREW (5/16"-18 X 5/16"), END CAP (NOT SHOWN)	S57U313313WA6L7	2	STEEL
A13	INSERT, BEARING HOUSING (NOT SHOWN)	0020-1790-400	2	NYLON
B1	BRACKET, ASSEMBLY (INCLUDES B2 THRU B8)	0820-2000-150	1	STAINLESS STEEL/CARBON GRAPHITE
B2	BUSHING, BRACKET	0820-2800-300	1	CARBON GRAPHITE
B3	FITTING, GREASE (1/8" NPT)	GRSF-013NST-230	1	STEEL
B4	PLUG, PIPE (1/4" NPT)	PLUG-025NSH-250	3	STAINLESS STEEL
B6	SCREWS (7/16"-14 X 1-1/4"), BRACKET	S01C438A25AE2A1	8	STAINLESS STEEL
B5	PLUG, PIPE (1/8" NPT)	PLUG-013NSH-250	1	STAINLESS STEEL
B7	GASKET, BRACKET	0550-2900-950	1	INTERFACE TS-9003
B8	BRACKET	0820-2100-150	1	STAINLESS STEEL
C1	CASE, 3" ANSI KIT (INCLUDES B6, B7, C2, F4, F5)	0820-3001-150	1	STAINLESS STEEL
C2	PLUG, PIPE (1/4" NPT)	PLUG-025NSH-250	2	STAINLESS STEEL
D1	ROTOR, ASSEMBLY (A/B CLEARANCE)	0820-4000-176	1	NITRONIC 60/STAINLESS STEEL
	ROTOR, ASSEMBLY (C CLEARANCE)	0820-4002-176	1	NITRONIC 60/STAINLESS STEEL
	ROTOR, ASSEMBLY (D CLEARANCE)	0820-4003-176	1	NITRONIC 60/STAINLESS STEEL
E1	GEAR, IDLER ASSEMBLY	0820-5000-176	1	NITRONIC 60/CARBON GRAPHITE
E2	BUSHING, IDLER	0820-5801-300	1	CARBON GRAPHITE
F1	HEAD, ASSEMBLY KIT (INCLUDES F2, F4, F5)	0820-6010-150	1	STAINLESS STEEL
F2	PIN, IDLER	0820-6200-254	1	STAINLESS STEEL/HARDENED
F4	CAPSCREW (7/16"-14 X 1-1/4"), HEAD	S01C438A25AE2A1	8	STAINLESS STEEL
F5	GASKET, HEAD	0550-2900-950	1	INTERFACE TS-9003
G1	VALVE, COVER ASSEMBLY (INCLUDES G2, G13 AND G14)	0550-7000-250	1	STAINLESS STEEL/STAINLESS STEEL
	VALVE, ASSEMBLY-60 PSI (INCLUDES G2 THRU G9, G11 THRU G14)	0550-7001-150	1	STAINLESS STEEL
	VALVE, ASSEMBLY-90 PSI (INCLUDES G2 THRU G9, G11 THRU G14)	0550-7002-150	1	STAINLESS STEEL
	VALVE, ASSEMBLY-150 PSI (INCLUDES G2 THRU G10, G12 THRU G14)	0550-7003-150	1	STAINLESS STEEL
G2	VALVE, BODY	0550-7100-150	1	STAINLESS STEEL
	VALVE, COVER (NOT SHOWN)	0550-7101-250	2	STAINLESS STEEL
G3	VALVE, GASKET BONNET	0240-7910-951	1	KLINGERSIL® C-4401
G4	VALVE, BONNET	0240-7200-150	1	STAINLESS STEEL
G5	VALVE, GASKET CAP	0240-7920-951	1	KLINGERSIL® C-4401
G6	VALVE, CAP	0240-7300-150	1	STAINLESS STEEL
G7	VALVE, ADJUSTMENT SCREW	0240-7700-255	1	STAINLESS STEEL
G8	VALVE, LOCK NUT	0240-7710-255	1	STAINLESS STEEL
G9	VALVE, SPRING GUIDE	0240-7500-250	1	STAINLESS STEEL
G10	VALVE, SPRING LARGE (USED WITH 150 PSI VALVES)	0240-7602-250	1	STAINLESS STEEL
G11	VALVE, SPRING SMALL (USED WITH 60 PSI VALVES)	0240-7600-250	1	STAINLESS STEEL
	VALVE, SPRING SMALL (USED WITH 90 PSI VALVES)	0240-7601-250	1	STAINLESS STEEL
G12	VALVE, POPPET	0240-7400-150	1	STAINLESS STEEL
G13	CAPSCREW (3/8"-16 X 3/4"), VALVE	S01C375750AE2A1	8	STAINLESS STEEL
G14	GASKET, VALVE	0550-7900-950	2	INTERFACE TS-9003
H1	GLAND, PACKING (TYPE 1)	0820-8200-150	1	STAINLESS STEEL
	GLAND, PACKING (TYPE 9)	0820-8201-150	1	STAINLESS STEEL
H2	NUT (7/16"-14), PACKING GLAND	N04C438375AA9A1	2	STAINLESS STEEL
H3	CAPSCREW (7/16"-14), PACKING GLAND	S01C438B50CLOA1	2	STAINLESS STEEL
H4	TYPE 9, COMPONENT SEAL	0820-8001-920	1	PTFE/Ni-RESIST
H6	PACKING, KIT (INCLUDES H7)	0820-8100-925K	1	PTFE - GRAPHITE
H7	WASHER, PACKING RETAINING	0820-8150-250	1	STAINLESS STEEL

Item	Description	G1-82	Qty.	Material
A1	HOUSING, BEARING ASSEMBLY (INCLUDES A2 THRU A13)	0820-1000-110	1	CAST IRON
A2	LOCKNUT, SHAFT	0820-1710-230	1	STEEL
A3	LOCKWASHER, SHAFT	0820-1720-230	1	STEEL
A4	ENDCAP, BEARING HOUSING	0820-1200-230	1	STEEL
A5	LIP SEAL, BEARING HOUSING	0820-1900-900	2	BUNA-N
A6	COLLAR, OUTER BEARING SPACER	0820-1300-230	1	STEEL
A7	BEARING	0820-1400-230	1	STEEL
A8	COLLAR, INNER BEARING SPACER	0820-1301-230	1	STEEL
A9	SEMI-ROUND RINGS	0820-1310-230	2	STEEL
A10	HOUSING, BEARING	0820-1100-110	1	CAST IRON
A11	SET SCREW (3/8"-16 X 1/2"), BEARING HOUSING (NOT SHOWN)	S57U375500WA6L7	2	STEEL
A12	SET SCREW (5/16"-18 X 5/16"), END CAP (NOT SHOWN)	S57U313313WA6L7	2	STEEL
A13	INSERT, BEARING HOUSING (NOT SHOWN)	0020-1790-400	2	NYLON
B1	BRACKET, ASSEMBLY (INCLUDES B2 THRU B8)	0820-2000-130	1	CARBON STEEL/CARBON GRAPHITE
		0820-2010-130	1	CARBON STEEL/BRONZE
B2	BUSHING, BRACKET	0820-2800-300	1	CARBON GRAPHITE
		0820-2800-320	1	BRONZE
B3	FITTING, GREASE (1/8" NPT)	GRSF-013NST-230	1	STEEL
B4	PLUG, PIPE (1/4" NPT)	PLUG-025NSH-230	3	STEEL
B5	PLUG, PIPE (1/8" NPT) (USED WITH LUBRICATED BUSHING)	PLUG-013NSH-230	1	STEEL
	FITTING, GREASE (1/8" NPT) (USED WITH NON-LUBRICATED BUSHING)	GRSF-013NST-230	1	STEEL
B6	SCREWS (7/16"-14 X 1-1/4"), BRACKET	S01C438A25WA2A8	8	STEEL
B7	GASKET, BRACKET	0550-2900-950	1	INTERFACE TS-9003
B8	BRACKET	0820-2100-130	1	CARBON STEEL
C1	CASE, 3" ANSI KIT (INCLUDES B6, B7, C2, F4, F5)	0820-3001-130	1	CARBON STEEL
C2	PLUG, PIPE (1/4" NPT)	PLUG-025NSH-230	2	STEEL
D1	ROTOR, ASSEMBLY (A/B CLEARANCE)	0820-4000-121	1	DUCTILE IRON/STEEL
	ROTOR, ASSEMBLY (C CLEARANCE)	0820-4002-121	1	DUCTILE IRON/STEEL
	ROTOR, ASSEMBLY (D CLEARANCE)	0820-4003-121	1	DUCTILE IRON/STEEL
	ROTOR, ASSEMBLY (E CLEARANCE)	0820-4004-121	1	DUCTILE IRON/STEEL
E1	GEAR, IDLER ASSEMBLY	0820-5000-110	1	CAST IRON/CARBON GRAPHITE
		0820-5010-110	1	CAST IRON/BRONZE
E2	BUSHING, IDLER	0820-5800-300	1	CARBON GRAPHITE
		0820-5800-320	1	BRONZE
F1	HEAD, ASSEMBLY KIT (F2 THRU F6)	0820-6010-130	1	CARBON STEEL/STEEL
F2	PIN, IDLER	0820-6200-231	1	HARDENED STEEL
F3	PLUG, PIPE (1/8" NPT) (USED WITH LUBRICATED BUSHING)	PLUG-013NSH-230	1	STEEL
	FITTING, GREASE PIN (1/8" NPT) (USED WITH NON-LUBRICATED BUSHING)	GRSF-013NST-230	1	STEEL
F4	CAPSCREW (7/16"-14 X 1-1/4"), HEAD	S01C438A25WA2A8	8	STEEL
F5	GASKET, HEAD	0550-2900-950	1	INTERFACE TS-9003
F6	PLUG, PIPE (1/4" NPT)	PLUG-025NSH-230	1	STEEL
G1	VALVE, COVER ASSEMBLY (INCLUDES G2, G13 AND G14)	0550-7000-230	1	STAINLESS STEEL/STEEL
	VALVE, ASSEMBLY-60 PSI (INCLUDES G2 THRU G9, G11 THRU G14)	0550-7001-130	1	CARBON STEEL
	VALVE, ASSEMBLY-90 PSI (INCLUDES G2 THRU G9, G11 THRU G14)	0550-7002-130	1	CARBON STEEL
	VALVE, ASSEMBLY-160 PSI (INCLUDES G2 THRU G10, G12 THRU G14)	0550-7003-130	1	CARBON STEEL
	VALVE, ASSEMBLY-200 PSI (INCLUDES G2 THRU G14)	0550-7004-130	1	CARBON STEEL
G2	VALVE, BODY	0550-7100-130	1	CARBON STEEL
	VALVE, COVER (NOT SHOWN)	0550-7101-250	2	STAINLESS STEEL
G3	VALVE, GASKET BONNET	0240-7910-951	1	KLINGERSIL® C-4401
G4	VALVE, BONNET	0240-7200-130	1	CARBON STEEL
G5	VALVE, GASKET CAP	0240-7920-951	1	KLINGERSIL® C-4401
G6	VALVE, CAP	0240-7300-110	1	CAST IRON
G7	VALVE, ADJUSTMENT SCREW	0240-7700-230	1	STEEL
G8	VALVE, LOCK NUT	0240-7710-230	1	STEEL
G9	VALVE, SPRING GUIDE	0240-7500-230	1	STEEL
G10	VALVE, SPRING LARGE (USED WITH 160 & 200 PSI VALVES)	0240-7602-250	1	STAINLESS STEEL
	VALVE, SPRING SMALL (USED WITH 60 PSI VALVES)	0240-7600-250	1	STAINLESS STEEL
G11	VALVE, SPRING SMALL (USED WITH 90 & 200 PSI VALVES)	0240-7601-250	1	STAINLESS STEEL
	VALVE, POPPET	0240-7400-110	1	CAST IRON
G12	VALVE, POPPET	0240-7400-110	1	CAST IRON
G13	CAPSCREW (3/8"-16 X 3/4"), VALVE	S01C375750WA2A2	8	STEEL
G14	GASKET, VALVE	0550-7900-950	2	INTERFACE TS-9003
H1	GLAND, PACKING (TYPE 1)	0820-8200-150	1	STAINLESS STEEL
	GLAND, PACKING (TYPE 9)	0820-8201-150	1	STAINLESS STEEL
H2	NUT (7/16"-14), PACKING GLAND	N04C438375AA9A1	2	STAINLESS STEEL
H3	CAPSCREW (7/16"-14), PACKING GLAND	S01C438B50CLOA1	2	STAINLESS STEEL
	TYPE 1, COMPONENT SEAL	0820-8000-910	1	VITON
H4	TYPE 9, COMPONENT SEAL	0820-8001-920	1	PTFE/Ni-RESIST
	COLLAR, MECHANICAL SEAL ASSEMBLY	0820-8050-250	1	STAINLESS STEEL
H5	COLLAR, MECHANICAL SEAL ASSEMBLY	0820-8050-250	1	STAINLESS STEEL
H6	PACKING, KIT (INCLUDES H7)	0820-8100-925K	1	PTFE - GRAPHITE
H7	WASHER, PACKING RETAINING	0820-8150-250	1	STAINLESS STEEL

**G1-133**

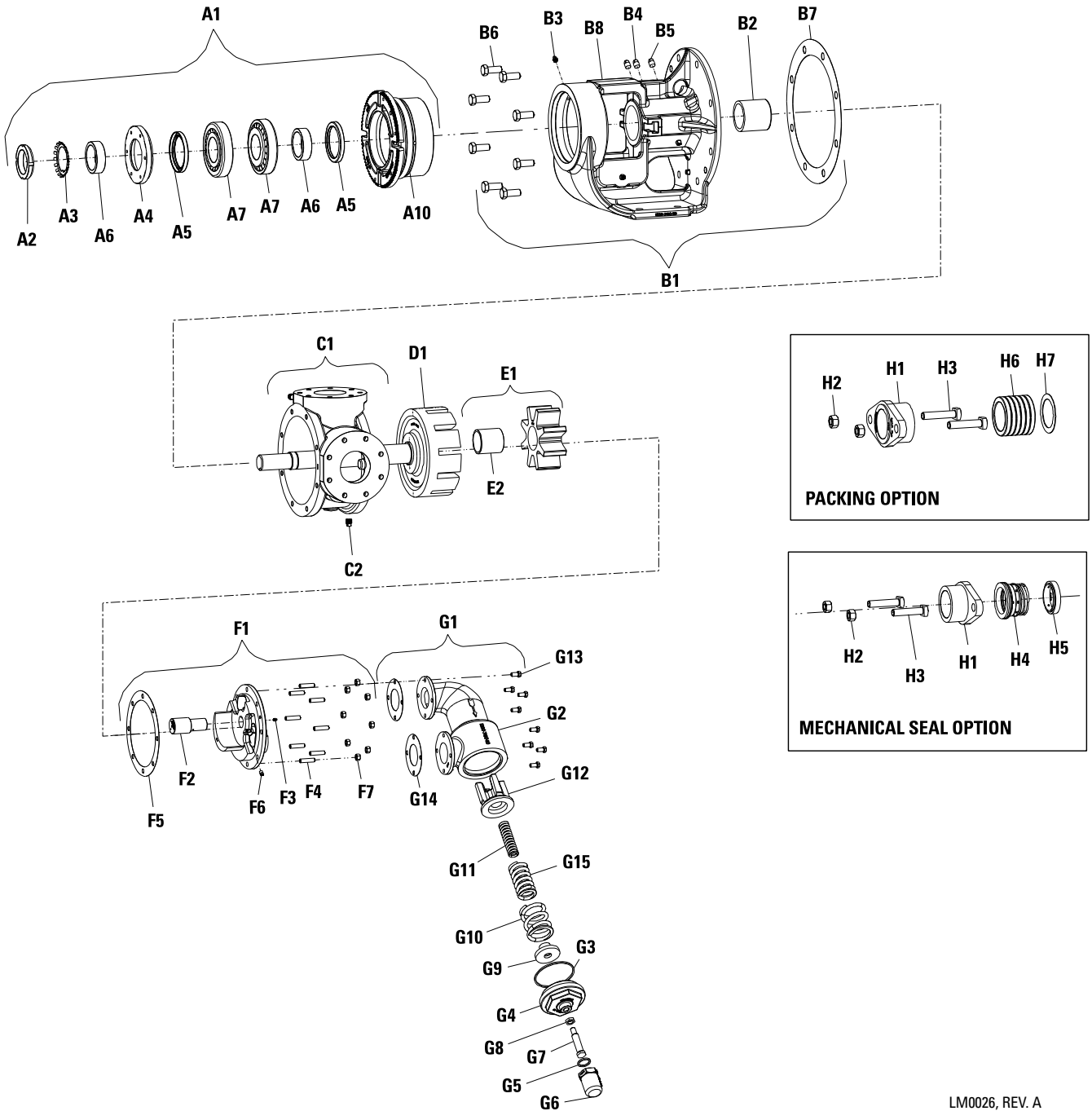

LM0026, REV. A

Item	Description	G1-133	Qty.	Material
A1	HOUSING, BEARING ASSEMBLY (INCLUDES A2 THRU A13)	1330-1000-110	1	CAST IRON
A2	LOCKNUT, SHAFT	1330-1710-230	1	STEEL
A3	LOCKWASHER, SHAFT	1330-1720-230	1	STEEL
A4	ENDCAP, BEARING HOUSING	1330-1200-230	1	STEEL
A5	LIP SEAL, BEARING HOUSING	1330-1900-900	2	BUNA-N
A6	COLLAR, OUTER BEARING SPACER	1330-1300-230	2	STEEL
A7	BEARING	1330-1400-230	2	STEEL
A10	HOUSING, BEARING	1330-1100-110	1	CAST IRON
A11	SET SCREW (3/8"-16 X 3/4"), BEARING HOUSING (NOT SHOWN)	S57U375750WA6L7	2	STEEL
A12	SET SCREW (5/16"-18 X 5/16"), END CAP (NOT SHOWN)	S57U313313WA6L7	2	STEEL
A13	INSERT, BEARING HOUSING (NOT SHOWN)	0020-1790-400	2	NYLON
B1	BRACKET, ASSEMBLY (INCLUDES B2 THRU B8)	1330-2000-110	1	CAST IRON/CARBON GRAPHITE
		1330-2010-110	1	CAST IRON/BRONZE
B2	BUSHING, BRACKET	1330-2800-300	1	CARBON GRAPHITE
		1330-2800-320	1	BRONZE
B3	FITTING, GREASE (1/8" NPT)	GRSF-013NST-230	1	STEEL
B4	PLUG, PIPE (1/4" NPT)	PLUG-025NSH-230	4	STEEL
B5	PLUG, PIPE (1/4" NPT) (USED WITH LUBRICATED BUSHING)	PLUG-025NSH-230	1	STEEL
	FITTING, GREASE PIN (1/4" NPT) (USED WITH NON-LUBRICATED BUSHING)	GRSF-025NST-230	1	STEEL
B6	SCREWS (5/8"-11 X 1-1/2"), BRACKET	S01C625A50WA2A4	8	STEEL
B7	GASKET, BRACKET	1330-6900-950	1	INTERFACE TS-9003
B8	BRACKET	1330-2100-110	1	CAST IRON
C1	CASE, 4" ANSI KIT (INCLUDES B6, B7, C2, F4, F5)	1330-3001-110	1	CAST IRON
C2	PLUG, PIPE (3/8" NPT)	PLUG-038NSH-230	2	STEEL
D1	ROTOR, ASSEMBLY (A/B CLEARANCE)	1330-4000-121	1	DUCTILE IRON/STEEL
	ROTOR, ASSEMBLY (C CLEARANCE)	1330-4002-121	1	DUCTILE IRON/STEEL
	ROTOR, ASSEMBLY (D CLEARANCE)	1330-4003-121	1	DUCTILE IRON/STEEL
E1	GEAR, IDLER ASSEMBLY	1330-5000-121	1	DUCTILE IRON/CARBON GRAPHITE
		1330-5010-121	1	DUCTILE IRON/BRONZE
E2	BUSHING, IDLER	1330-5800-300	1	CARBON GRAPHITE
		1330-5800-320	1	BRONZE
F1	HEAD, ASSEMBLY KIT (F2 THRU F7)	1330-6010-110	1	CAST IRON/STEEL
F2	PIN, IDLER	1330-6200-231	1	HARDENED STEEL
F3	PLUG, PIPE (1/8" NPT) (USED WITH LUBRICATED BUSHING)	PLUG-013NSH-230	1	STEEL
	FITTING, GREASE PIN (1/8" NPT) (USED WITH NON-LUBRICATED BUSHING)	GRSF-013NST-230	1	STEEL
F4	STUD, HEAD, (5/8"-11 X 2-1/2")	T09C625B50WA2A2	8	STEEL
F5	GASKET, HEAD	1330-6900-950	1	INTERFACE TS-9003
F6	PLUG, PIPE (1/4" NPT)	PLUG-025NSH-230	1	STEEL
F7	NUT, HEAD, (5/8"-11)	N04C625562WA2A2	8	STEEL
G1	VALVE, COVER ASSEMBLY (INCLUDES G2, G13 AND G14)	1330-7000-230	1	STAINLESS STEEL/STEEL
	VALVE, ASSEMBLY-50 PSI (INCLUDES G2 THRU G9, G11 THRU G14)	1330-7001-110	1	CAST IRON
	VALVE, ASSEMBLY-80 PSI (INCLUDES G2 THRU G9, G12 THRU G15)	1330-7002-110	1	CAST IRON
	VALVE, ASSEMBLY-130 PSI (INCLUDES G2 THRU G9, G11 THRU G15)	1330-7003-110	1	CAST IRON
	VALVE, ASSEMBLY-200 PSI (INCLUDES G2 THRU G15)	1330-7004-110	1	CAST IRON
G2	VALVE, BODY	1330-7100-110	1	CAST IRON
	VALVE, COVER (NOT SHOWN)	1330-7101-250	2	STAINLESS STEEL
G3	VALVE, GASKET BONNET	1330-7910-951	1	KLINGERSIL® C-4401
G4	VALVE, BONNET	1330-7200-110	1	CAST IRON
G5	VALVE, GASKET CAP	1330-7920-951	1	KLINGERSIL® C-4401
G6	VALVE, CAP	1330-7300-110	1	CAST IRON
G7	VALVE, ADJUSTMENT SCREW	1330-7700-255	1	STAINLESS STEEL
G8	VALVE, LOCK NUT	1330-7710-255	1	STAINLESS STEEL
G9	VALVE, SPRING GUIDE	1330-7500-250	1	STAINLESS STEEL
G10	VALVE, SPRING LARGE (USED WITH 200 PSI VALVES)	1330-7602-250	1	STAINLESS STEEL
G11	VALVE, SPRING SMALL (USED WITH 50, 130, 200 PSI VALVES)	1330-7600-250	1	STAINLESS STEEL
G12	VALVE, POPPET	1330-7400-110	1	CAST IRON
G13	CAPSCREW (3/8"-16 X 3/4"), VALVE	S01C375750WA2A2	8	STEEL
G14	GASKET, VALVE	1330-7900-950	2	INTERFACE TS-9003
G15	VALVE, SPRING MEDIUM (USED WITH 80, 130, 200 PSI VALVES)	1330-7601-250	1	STAINLESS STEEL
H1	GLAND, PACKING (TYPE 1)	1330-8200-150	1	STAINLESS STEEL
	GLAND, PACKING (TYPE 9)	1330-8201-150	1	STAINLESS STEEL
H2	NUT (5/8"-11), PACKING GLAND	N04C625562CLOA1	2	STAINLESS STEEL
H3	CAPSCREW (5/8"-11), PACKING GLAND	B01C625C00CLOA1	2	STAINLESS STEEL
H4	TYPE 1, COMPONENT SEAL	1330-8000-910	1	VITON
	TYPE 9, COMPONENT SEAL	1330-8001-920	1	PTFE/Ni-RESIST
H5	COLLAR, MECHANICAL SEAL ASSEMBLY	1330-8050-250	1	STAINLESS STEEL
H6	PACKING, KIT (INCLUDES H7)	1330-8100-925K	1	PTFE - GRAPHITE
H7	WASHER, PACKING RETAINING	1330-8150-250	1	STAINLESS STEEL

Item	Description	G1-133	Qty.	Material
A1	HOUSING, BEARING ASSEMBLY (INCLUDES A2 THRU A13)	1330-1000-110	1	CAST IRON
A2	LOCKNUT, SHAFT	1330-1710-230	1	STEEL
A3	LOCKWASHER, SHAFT	1330-1720-230	1	STEEL
A4	ENDCAP, BEARING HOUSING	1330-1200-230	1	STEEL
A5	LIP SEAL, BEARING HOUSING	1330-1900-900	2	BUNA-N
A6	COLLAR, OUTER BEARING SPACER	1330-1300-230	2	STEEL
A7	BEARING	1330-1400-230	2	STEEL
A10	HOUSING, BEARING	1330-1100-110	1	CAST IRON
A11	SET SCREW (3/8"-16 X 3/4"), BEARING HOUSING (NOT SHOWN)	S57U375750WA6L7	2	STEEL
A12	SET SCREW (5/16"-18 X 5/16"), END CAP (NOT SHOWN)	S57U313313WA6L7	2	STEEL
A13	INSERT, BEARING HOUSING (NOT SHOWN)	0020-1790-400	2	NYLON
B1	BRACKET, ASSEMBLY (INCLUDES B2 THRU B8)	1330-2000-150	1	STAINLESS STEEL/CARBON GRAPHITE
B2	BUSHING, BRACKET	1330-2800-300	1	CARBON GRAPHITE
B3	FITTING, GREASE (1/8" NPT)	GRSF-013NST-230	1	STEEL
B4	PLUG, PIPE (1/4" NPT)	PLUG-025NSH-250	4	STAINLESS STEEL
B5	PLUG, PIPE (1/4" NPT)	PLUG-025NSH-250	1	STAINLESS STEEL
B6	SCREWS (5/8"-11 X 1-1/2"), BRACKET	S01C625A50AE2A1	8	STAINLESS STEEL
B7	GASKET, BRACKET	1330-6900-950	1	INTERFACE TS-9003
B8	BRACKET	1330-2100-150	1	STAINLESS STEEL
C1	CASE, 4" ANSI KIT (INCLUDES B6, B7, C2, F4, F5)	1330-3001-150	1	STAINLESS STEEL
C2	PLUG, PIPE (3/8" NPT)	PLUG-038NSH-250	2	STAINLESS STEEL
D1	ROTOR, ASSEMBLY (A CLEARANCE)	1330-4000-176	1	NITRONIC 60/STAINLESS STEEL
	ROTOR, ASSEMBLY (B CLEARANCE)	1330-4001-176	1	NITRONIC 60/STAINLESS STEEL
	ROTOR, ASSEMBLY (C CLEARANCE)	1330-4002-176	1	NITRONIC 60/STAINLESS STEEL
E1	GEAR, IDLER ASSEMBLY	1330-5000-176	1	NITRONIC 60/CARBON GRAPHITE
E2	BUSHING, IDLER	1330-5801-300	1	CARBON GRAPHITE
F1	HEAD, ASSEMBLY KIT (F2, F4, F5, F7)	1330-6010-150	1	STAINLESS STEEL
F2	PIN, IDLER	1330-6200-254	1	STAINLESS STEEL/KOLSTERISED
F4	STUD, HEAD, (5/8"-11 X 2-1/2")	T09C625B50AE2A1	8	STAINLESS STEEL
F5	GASKET, HEAD	1330-6900-950	1	INTERFACE TS-9003
F7	NUT, HEAD, (5/8"-11)	N04C625562AE2A1	8	STAINLESS STEEL
G1	VALVE, COVER ASSEMBLY (INCLUDES G2, G13 AND G14)	1330-7000-250	1	STAINLESS STEEL/STAINLESS STEEL
	VALVE, ASSEMBLY-50 PSI (INCLUDES G2 THRU G9, G11 THRU G14)	1330-7001-150	1	STAINLESS STEEL
	VALVE, ASSEMBLY-80 PSI (INCLUDES G2 THRU G9, G12 THRU G15)	1330-7002-150	1	STAINLESS STEEL
	VALVE, ASSEMBLY-130 PSI (INCLUDES G2 THRU G9, G11 THRU G15)	1330-7003-150	1	STAINLESS STEEL
	VALVE, ASSEMBLY-150 PSI (INCLUDES G2 THRU G15)	1330-7004-150	1	STAINLESS STEEL
G2	VALVE, BODY	1330-7100-150	1	STAINLESS STEEL
	VALVE, COVER (NOT SHOWN)	1330-7101-250	2	STAINLESS STEEL
G3	VALVE, GASKET BONNET	1330-7910-951	1	KLINGERSIL® C-4401
G4	VALVE, BONNET	1330-7200-150	1	STAINLESS STEEL
G5	VALVE, GASKET CAP	1330-7920-951	1	KLINGERSIL® C-4401
G6	VALVE, CAP	1330-7300-150	1	STAINLESS STEEL
G7	VALVE, ADJUSTMENT SCREW	1330-7700-255	1	STAINLESS STEEL
G8	VALVE, LOCK NUT	1330-7710-255	1	STAINLESS STEEL
G9	VALVE, SPRING GUIDE	1330-7500-250	1	STAINLESS STEEL
G10	VALVE, SPRING LARGE (USED WITH 150 PSI VALVES)	1330-7602-250	1	STAINLESS STEEL
G11	VALVE, SPRING SMALL (USED WITH 50, 130, 150 PSI VALVES)	1330-7600-250	1	STAINLESS STEEL
G12	VALVE, POPPET	1330-7400-150	1	STAINLESS STEEL
G13	CAPSCREW (3/8"-16 X 3/4"), VALVE	S01C375750AE2A1	8	STAINLESS STEEL
G14	GASKET, VALVE	1330-7900-950	2	INTERFACE TS-9003
G15	VALVE SPRING MEDIUM (USED WITH 80, 130, 150 PSI VALVES)	1330-7601-250	1	STAINLESS STEEL
H1	GLAND, PACKING (TYPE 1)	1330-8200-150	1	STAINLESS STEEL
	GLAND, PACKING (TYPE 9)	1330-8201-150	1	STAINLESS STEEL
H2	NUT (5/8"-11), PACKING GLAND	N04C625562CLOA1	2	STAINLESS STEEL
H3	CAPSCREW (5/8"-11), PACKING GLAND	B01C625C00CLOA1	2	STAINLESS STEEL
H4	TYPE 9, COMPONENT SEAL	1330-8001-920	1	PTFE/ Ni-RESIST
H6	PACKING, KIT (INCLUDES H7)	1330-8100-925K	1	PTFE - GRAPHITE
H7	WASHER, PACKING RETAINING	1330-8150-250	1	STAINLESS STEEL

Item	Description	G1-133	Qty.	Material
A1	HOUSING, BEARING ASSEMBLY (INCLUDES A2 THRU A13)	1330-1000-110	1	CAST IRON
A2	LOCKNUT, SHAFT	1330-1710-230	1	STEEL
A3	LOCKWASHER, SHAFT	1330-1720-230	1	STEEL
A4	ENDCAP, BEARING HOUSING	1330-1200-230	1	STEEL
A5	LIP SEAL, BEARING HOUSING	1330-1900-900	2	BUNA-N
A6	COLLAR, OUTER BEARING SPACER	1330-1300-230	2	STEEL
A7	BEARING	1330-1400-230	2	STEEL
A10	HOUSING, BEARING	1330-1100-110	1	CAST IRON
A11	SET SCREW (3/8"-16 X 3/4"), BEARING HOUSING (NOT SHOWN)	S57U375750WA6L7	2	STEEL
A12	SET SCREW (5/16"-18 X 5/16"), END CAP (NOT SHOWN)	S57U313313WA6L7	2	STEEL
A13	INSERT, BEARING HOUSING (NOT SHOWN)	0020-1790-400	2	NYLON
B1	BRACKET, ASSEMBLY (INCLUDES B2 THRU B8)	1330-2000-130	1	CARBON STEEL/CARBON GRAPHITE
		1330-2010-130	1	CARBON STEEL/BRONZE
B2	BUSHING, BRACKET	1330-2800-300	1	CARBON GRAPHITE
		1330-2800-320	1	BRONZE
B3	FITTING, GREASE (1/8" NPT)	GRSF-013NST-230	1	STEEL
B4	PLUG, PIPE (1/4" NPT)	PLUG-025NSH-230	4	STEEL
B5	PLUG, PIPE (1/4" NPT) (USED WITH LUBRICATED BUSHING)	PLUG-025NSH-230	1	STEEL
	FITTING, GREASE PIN (1/4" NPT) (USED WITH NON-LUBRICATED BUSHING)	GRSF-025NST-230	1	STEEL
B6	SCREWS (5/8"-11 X 1-1/2"), BRACKET	S01C625A50WA2A4	8	STEEL
B7	GASKET, BRACKET	1330-6900-950	1	INTERFACE TS-9003
B8	BRACKET	1330-2100-130	1	CARBON STEEL
C1	CASE, 4" ANSI KIT (INCLUDES B6, B7, C2, F4, F5)	1330-3001-130	1	CARBON STEEL
C2	PLUG, PIPE (3/8" NPT)	PLUG-038NSH-230	2	STEEL
D1	ROTOR, ASSEMBLY (A/B CLEARANCE)	1330-4000-121	1	DUCTILE IRON/STEEL
	ROTOR, ASSEMBLY (C CLEARANCE)	1330-4002-121	1	DUCTILE IRON/STEEL
	ROTOR, ASSEMBLY (D CLEARANCE)	1330-4003-121	1	DUCTILE IRON/STEEL
E1	GEAR, IDLER ASSEMBLY	1330-5000-121	1	DUCTILE IRON/CARBON GRAPHITE
		1330-5010-121	1	DUCTILE IRON/BRONZE
E2	BUSHING, IDLER	1330-5800-300	1	CARBON GRAPHITE
		1330-5800-320	1	BRONZE
F1	HEAD, ASSEMBLY KIT (F2 THRU F7)	1330-6010-130	1	CARBON STEEL/STEEL
F2	PIN, IDLER	1330-6200-231	1	HARDENED STEEL
F3	PLUG, PIPE (1/8" NPT) (USED WITH LUBRICATED BUSHING)	PLUG-013NSH-230	1	STEEL
	FITTING, GREASE PIN (1/8" NPT) (USED WITH NON-LUBRICATED BUSHING)	GRSF-013NST-230	1	STEEL
F4	STUD, HEAD, (5/8"-11 X 2-1/2")	T09C625B50WA2A2	8	STEEL
F5	GASKET, HEAD	1330-6900-950	1	INTERFACE TS-9003
F6	PLUG, PIPE (1/4" NPT)	PLUG-025NSH-230	1	STEEL
F7	NUT, HEAD, (5/8"-11)	N04C625562WA2A2	8	STEEL
G1	VALVE, COVER ASSEMBLY (INCLUDES G2, G13 AND G14)	1330-7000-230	1	STAINLESS STEEL/STEEL
	VALVE, ASSEMBLY-50 PSI (INCLUDES G2 THRU G9, G11 THRU G14)	1330-7001-130	1	CARBON STEEL
	VALVE, ASSEMBLY-80 PSI (INCLUDES G2 THRU G9, G12 THRU G15)	1330-7002-130	1	CARBON STEEL
	VALVE, ASSEMBLY-130 PSI (INCLUDES G2 THRU G9, G11 THRU G15)	1330-7003-130	1	CARBON STEEL
	VALVE, ASSEMBLY-200 PSI (INCLUDES G2 THRU G15)	1330-7004-130	1	CARBON STEEL
G2	VALVE, BODY	1330-7100-130	1	CARBON STEEL
	VALVE, COVER (NOT SHOWN)	1330-7101-250	2	STAINLESS STEEL
G3	VALVE, GASKET BONNET	1330-7910-951	1	KLINGERSIL® C-4401
G4	VALVE, BONNET	1330-7200-130	1	CARBON STEEL
G5	VALVE, GASKET CAP	1330-7920-951	1	KLINGERSIL® C-4401
G6	VALVE, CAP	1330-7300-110	1	CAST IRON
G7	VALVE, ADJUSTMENT SCREW	1330-7700-255	1	STAINLESS STEEL
G8	VALVE, LOCK NUT	1330-7710-255	1	STAINLESS STEEL
G9	VALVE, SPRING GUIDE	1330-7500-250	1	STAINLESS STEEL
G10	VALVE, SPRING LARGE (USED WITH 200 PSI VALVES)	1330-7602-250	1	STAINLESS STEEL
G11	VALVE, SPRING SMALL (USED WITH 50, 130, 200 PSI VALVES)	1330-7600-250	1	STAINLESS STEEL
G12	VALVE, POPPET	1330-7400-110	1	CAST IRON
G13	CAPSCREW (3/8"-16 X 3/4"), VALVE	S01C375750WA2A2	8	STEEL
G14	GASKET, VALVE	1330-7900-950	2	INTERFACE TS-9003
G15	VALVE, SPRING MEDIUM (USED WITH 80, 130, 200 PSI VALVES)	1330-7601-250	1	STAINLESS STEEL
H1	GLAND, PACKING (TYPE 1)	1330-8200-150	1	STAINLESS STEEL
	GLAND, PACKING (TYPE 9)	1330-8201-150	1	STAINLESS STEEL
H2	NUT (5/8"-11), PACKING GLAND	N04C625562CLOA1	2	STAINLESS STEEL
H3	CAPSCREW (5/8"-11), PACKING GLAND	B01C625C00CLOA1	2	STAINLESS STEEL
H4	TYPE 1, COMPONENT SEAL	1330-8000-910	1	VITON
	TYPE 9, COMPONENT SEAL	1330-8001-920	1	PTFE/Ni-RESIST
H5	COLLAR, MECHANICAL SEAL ASSEMBLY	1330-8050-250	1	STAINLESS STEEL
H6	PACKING, KIT (INCLUDES H7)	1330-8100-925K	1	PTFE - GRAPHITE
H7	WASHER, PACKING RETAINING	1330-8150-250	1	STAINLESS STEEL

# G1-222

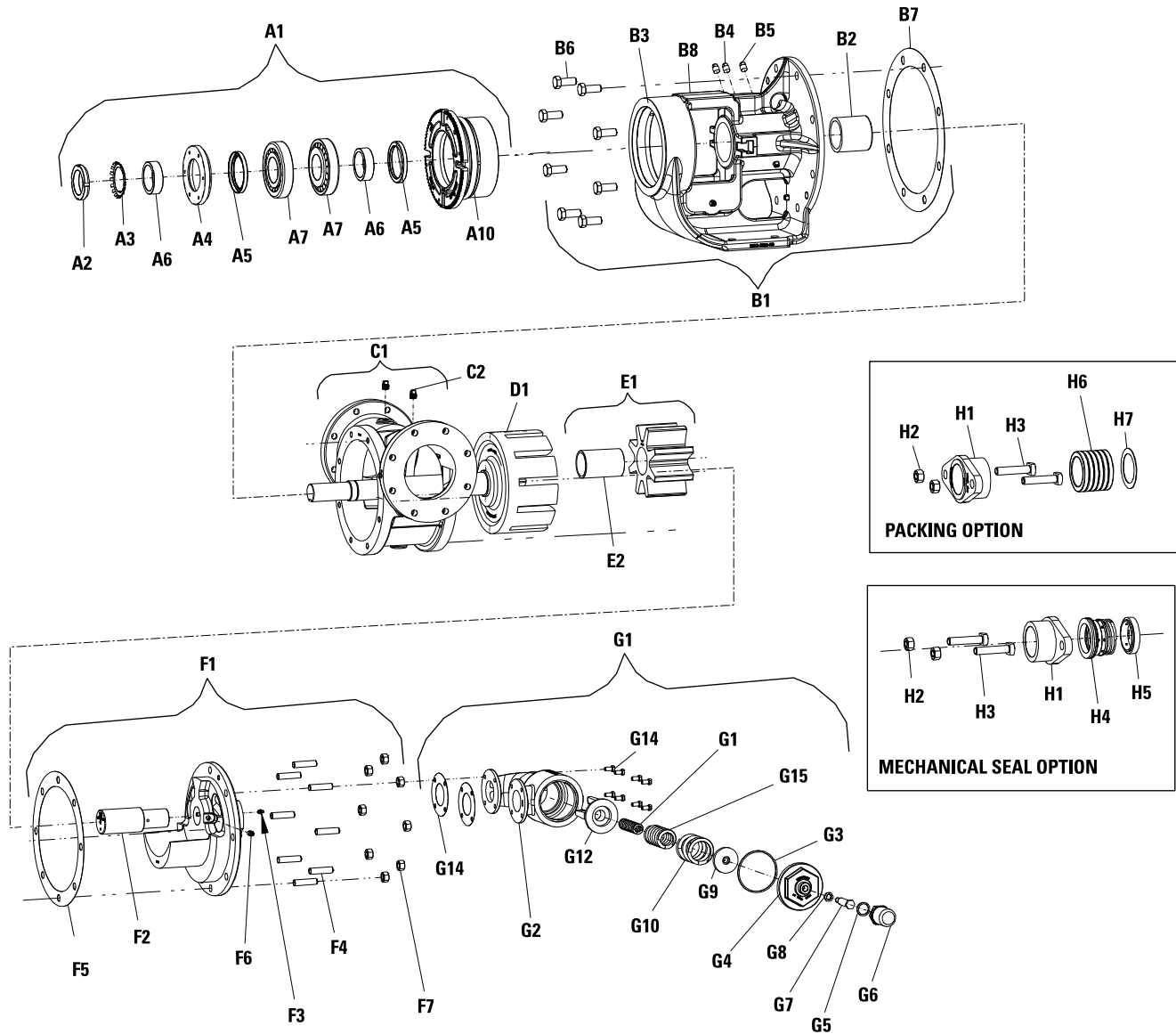

LM0027, REV. A

Item	Description	G1-222	Qty.	Material
A1	HOUSING, BEARING ASSEMBLY (INCLUDES A2 THRU A13)	1330-1000-110	1	CAST IRON
A2	LOCKNUT, SHAFT	1330-1710-230	1	STEEL
A3	LOCKWASHER, SHAFT	1330-1720-230	1	STEEL
A4	ENDCAP, BEARING HOUSING	1330-1200-230	1	STEEL
A5	LIP SEAL, BEARING HOUSING	1330-1900-900	2	BUNA-N
A6	COLLAR, OUTER BEARING SPACER	1330-1300-230	2	STEEL
A7	BEARING	1330-1400-230	2	STEEL
A10	HOUSING, BEARING	1330-1100-110	1	CAST IRON
A11	SET SCREW (3/8"-16 X 3/4"), BEARING HOUSING (NOT SHOWN)	S57U375750WA6L7	2	STEEL
A12	SET SCREW (5/16"-18 X 5/16"), END CAP (NOT SHOWN)	S57U313313WA6L7	2	STEEL
A13	INSERT, BEARING HOUSING (NOT SHOWN)	0020-1790-400	2	NYLON
B1	BRACKET, ASSEMBLY (INCLUDES B2 THRU B8)	1330-2000-110	1	CAST IRON/CARBON GRAPHITE
		1330-2010-110	1	CAST IRON/BRONZE
B2	BUSHING, BRACKET	1330-2800-300	1	CARBON GRAPHITE
		1330-2800-320	1	BRONZE
B3	FITTING, GREASE (1/8" NPT)	GRSF-013NST-230	1	STEEL
B4	PLUG, PIPE (1/4" NPT)	PLUG-025NSH-230	4	STEEL
B5	PLUG, PIPE (1/4" NPT) (USED WITH LUBRICATED BUSHING)	PLUG-025NSH-230	1	STEEL
	FITTING, GREASE PIN (1/4" NPT) (USED WITH NON-LUBRICATED BUSHING)	GRSF-025NST-230	1	STEEL
B6	SCREWS (5/8"-11 X 1-1/2"), BRACKET	S01C625A50WA2A4	8	STEEL
B7	GASKET, BRACKET	1330-6900-950	1	INTERFACE TS-9003
B8	BRACKET	1330-2100-110	1	CAST IRON
C1	CASE, 6" ANSI KIT (INCLUDES B6, B7, C2, F4, F5)	2220-3001-110	1	CAST IRON
C2	PLUG, PIPE (3/8" NPT)	PLUG-038NSH-230	2	STEEL
D1	ROTOR, ASSEMBLY (A/B CLEARANCE)	2220-4000-121	1	DUCTILE IRON/STEEL
	ROTOR, ASSEMBLY (C CLEARANCE)	2220-4002-121	1	DUCTILE IRON/STEEL
	ROTOR, ASSEMBLY (D CLEARANCE)	2220-4003-121	1	DUCTILE IRON/STEEL
E1	GEAR, IDLER ASSEMBLY	2220-5000-121	1	DUCTILE IRON/CARBON GRAPHITE
		2220-5010-121	1	DUCTILE IRON/BRONZE
E2	BUSHING, IDLER	2220-5800-300	1	CARBON GRAPHITE
		2220-5800-320	1	BRONZE
F1	HEAD, ASSEMBLY KIT (F2 THRU F7)	2220-6010-110	1	CAST IRON/STEEL
F2	PIN, IDLER	2220-6200-231	1	HARDENED STEEL
F3	PLUG, PIPE (1/8" NPT) (USED WITH LUBRICATED BUSHING)	PLUG-013NSH-230	1	STEEL
	FITTING, GREASE PIN (1/8" NPT) (USED WITH NON-LUBRICATED BUSHING)	GRSF-013NST-230	1	STEEL
F4	STUD, HEAD, (5/8"-11 X 2-1/2")	T09C625B50WA2A2	8	STEEL
F5	GASKET, HEAD	1330-6900-950	1	INTERFACE TS-9003
F6	PLUG, PIPE (1/4" NPT)	PLUG-025NSH-230	1	STEEL
F7	NUT, HEAD, (5/8"-11)	N04C625562WA2A2	8	STEEL
G1	VALVE, COVER ASSEMBLY (INCLUDES G2, G13 AND G14)	1330-7000-230	1	STAINLESS STEEL/STEEL
	VALVE, ASSEMBLY-50 PSI (INCLUDES G2 THRU G9, G11 THRU G14)	1330-7001-110	1	CAST IRON
	VALVE, ASSEMBLY-80 PSI (INCLUDES G2 THRU G9, G12 THRU G15)	1330-7002-110	1	CAST IRON
	VALVE, ASSEMBLY-130 PSI (INCLUDES G2 THRU G9, G11 THRU G15)	1330-7003-110	1	CAST IRON
	VALVE, ASSEMBLY-200 PSI (INCLUDES G2 THRU G15)	1330-7004-110	1	CAST IRON
G2	VALVE, BODY	1330-7100-110	1	CAST IRON
	VALVE, COVER (NOT SHOWN)	1330-7101-250	2	STAINLESS STEEL
G3	VALVE, GASKET BONNET	1330-7910-951	1	KLINGERSIL® C-4401
G4	VALVE, BONNET	1330-7200-110	1	CAST IRON
G5	VALVE, GASKET CAP	1330-7920-951	1	KLINGERSIL® C-4401
G6	VALVE, CAP	1330-7300-110	1	CAST IRON
G7	VALVE, ADJUSTMENT SCREW	1330-7700-255	1	STAINLESS STEEL
G8	VALVE, LOCK NUT	1330-7710-255	1	STAINLESS STEEL
G9	VALVE, SPRING GUIDE	1330-7500-250	1	STAINLESS STEEL
G10	VALVE, SPRING LARGE (USED WITH 200 PSI VALVES)	1330-7602-250	1	STAINLESS STEEL
G11	VALVE, SPRING SMALL (USED WITH 50, 130, 200 PSI VALVES)	1330-7600-250	1	STAINLESS STEEL
G12	VALVE, POPPET	1330-7400-110	1	CAST IRON
G13	CAPSCREW (3/8"-16 X 3/4"), VALVE	S01C375750WA2A2	8	STEEL
G14	GASKET, VALVE	1330-7900-950	2	INTERFACE TS-9003
G15	VALVE, SPRING MEDIUM (USED WITH 80, 130, 200 PSI VALVES)	1330-7601-250	1	STAINLESS STEEL
H1	GLAND, PACKING (TYPE 1)	1330-8200-150	1	STAINLESS STEEL
	GLAND, PACKING (TYPE 9)	1330-8201-150	1	STAINLESS STEEL
H2	NUT (5/8"-11), PACKING GLAND	N04C625562CLOA1	2	STAINLESS STEEL
H3	CAPSCREW (5/8"-11), PACKING GLAND	B01C625C00CLOA1	2	STAINLESS STEEL
H4	TYPE 1, COMPONENT SEAL	1330-8000-910	1	VITON
	TYPE 9, COMPONENT SEAL	1330-8001-920	1	PTFE/Ni-RESIST
H5	COLLAR, MECHANICAL SEAL ASSEMBLY	1330-8050-250	1	STAINLESS STEEL
H6	PACKING, KIT (INCLUDES H7)	1330-8100-925K	1	PTFE - GRAPHITE
H7	WASHER, PACKING RETAINING	1330-8150-250	1	STAINLESS STEEL

Item	Description	G1-222	Qty.	Material
A1	HOUSING, BEARING ASSEMBLY (INCLUDES A2 THRU A13)	1330-1000-110	1	CAST IRON
A2	LOCKNUT, SHAFT	1330-1710-230	1	STEEL
A3	LOCKWASHER, SHAFT	1330-1720-230	1	STEEL
A4	ENDCAP, BEARING HOUSING	1330-1200-230	1	STEEL
A5	LIP SEAL, BEARING HOUSING	1330-1900-900	2	BUNA-N
A6	COLLAR, OUTER BEARING SPACER	1330-1300-230	2	STEEL
A7	BEARING	1330-1400-230	2	STEEL
A10	HOUSING, BEARING	1330-1100-110	1	CAST IRON
A11	SET SCREW (3/8"-16 X 3/4"), BEARING HOUSING (NOT SHOWN)	S57U375750WA6L7	2	STEEL
A12	SET SCREW (5/16"-18 X 5/16"), END CAP (NOT SHOWN)	S57U313313WA6L7	2	STEEL
A13	INSERT, BEARING HOUSING (NOT SHOWN)	0020-1790-400	2	NYLON
B1	BRACKET, ASSEMBLY (INCLUDES B2 THRU B8)	1330-2000-150	1	STAINLESS STEEL/CARBON GRAPHITE
B2	BUSHING, BRACKET	1330-2800-300	1	CARBON GRAPHITE
B3	FITTING, GREASE (1/8" NPT)	GRSF-013NST-230	1	STEEL
B4	PLUG, PIPE (1/4" NPT)	PLUG-025NSH-250	4	STAINLESS STEEL
B5	PLUG, PIPE (1/4" NPT)	PLUG-025NSH-250	1	STAINLESS STEEL
B6	SCREWS (5/8"-11 X 1-1/2"), BRACKET	S01C625A50AE2A1	8	STAINLESS STEEL
B7	GASKET, BRACKET	1330-6900-950	1	INTERFACE TS-9003
B8	BRACKET	1330-2100-150	1	STAINLESS STEEL
C1	CASE, 6" ANSI KIT (INCLUDES B6, B7, C2, F4, F5)	2220-3001-150	1	STAINLESS STEEL
C2	PLUG, PIPE (3/8" NPT)	PLUG-038NSH-250	2	STAINLESS STEEL
D1	ROTOR, ASSEMBLY (A CLEARANCE)	2220-4000-176	1	NITRONIC 60/STAINLESS STEEL
	ROTOR, ASSEMBLY (B CLEARANCE)	2220-4001-176	1	NITRONIC 60/STAINLESS STEEL
	ROTOR, ASSEMBLY (C CLEARANCE)	2220-4002-176	1	NITRONIC 60/STAINLESS STEEL
E1	GEAR, IDLER ASSEMBLY	2220-5000-176	1	NITRONIC 60/CARBON GRAPHITE
E2	BUSHING, IDLER	2220-5801-300	1	CARBON GRAPHITE
F1	HEAD, ASSEMBLY KIT (F2, F4, F5, F7)	2220-6010-150	1	STAINLESS STEEL
F2	PIN, IDLER	2220-6200-254	1	STAINLESS STEEL/HARDENED
F4	STUD, HEAD, (5/8"-11 X 2-1/2")	T09C625B50AE2A1	8	STAINLESS STEEL
F5	GASKET, HEAD	1330-6900-950	1	INTERFACE TS-9003
F7	NUT, HEAD, (5/8"-11)	N04C625562AE2A1	8	STAINLESS STEEL
G1	VALVE, COVER ASSEMBLY (INCLUDES G2, G13 AND G14)	1330-7000-250	1	STAINLESS STEEL/STAINLESS STEEL
	VALVE, ASSEMBLY-50 PSI (INCLUDES G2 THRU G9, G11 THRU G14)	1330-7001-150	1	STAINLESS STEEL
	VALVE, ASSEMBLY-80 PSI (INCLUDES G2 THRU G9, G12 THRU G15)	1330-7002-150	1	STAINLESS STEEL
	VALVE, ASSEMBLY-130 PSI (INCLUDES G2 THRU G9, G11 THRU G15)	1330-7003-150	1	STAINLESS STEEL
	VALVE, ASSEMBLY-150 PSI (INCLUDES G2 THRU G15)	1330-7004-150	1	STAINLESS STEEL
G2	VALVE, BODY	1330-7100-150	1	STAINLESS STEEL
	VALVE, COVER (NOT SHOWN)	1330-7101-250	2	STAINLESS STEEL
G3	VALVE, GASKET BONNET	1330-7910-951	1	KLINGERSIL® C-4401
G4	VALVE, BONNET	1330-7200-150	1	STAINLESS STEEL
G5	VALVE, GASKET CAP	1330-7920-951	1	KLINGERSIL® C-4401
G6	VALVE, CAP	1330-7300-150	1	STAINLESS STEEL
G7	VALVE, ADJUSTMENT SCREW	1330-7700-255	1	STAINLESS STEEL
G8	VALVE, LOCK NUT	1330-7710-255	1	STAINLESS STEEL
G9	VALVE, SPRING GUIDE	1330-7500-250	1	STAINLESS STEEL
G10	VALVE, SPRING LARGE (USED WITH 150 PSI VALVES)	1330-7602-250	1	STAINLESS STEEL
G11	VALVE, SPRING SMALL (USED WITH 50, 130, 150 PSI VALVES)	1330-7600-250	1	STAINLESS STEEL
G12	VALVE, POPPET	1330-7400-150	1	STAINLESS STEEL
G13	CAPSCREW (3/8"-16 X 3/4"), VALVE	S01C375750AE2A1	8	STAINLESS STEEL
G14	GASKET, VALVE	1330-7900-950	2	INTERFACE TS-9003
G15	VALVE SPRING MEDIUM (USED WITH 80, 130, 150 PSI VALVES)	1330-7601-250	1	STAINLESS STEEL
H1	GLAND, PACKING (TYPE 1)	1330-8200-150	1	STAINLESS STEEL
	GLAND, PACKING (TYPE 9)	1330-8201-150	1	STAINLESS STEEL
H2	NUT (5/8"-11), PACKING GLAND	N04C625562CLOA1	2	STAINLESS STEEL
H3	CAPSCREW (5/8"-11), PACKING GLAND	B01C625C00CLOA1	2	STAINLESS STEEL
H4	TYPE 9, COMPONENT SEAL	1330-8001-920	1	PTFE/ Ni-RESIST
H6	PACKING, KIT (INCLUDES H7)	1330-8100-925K	1	PTFE - GRAPHITE
H7	WASHER, PACKING RETAINING	1330-8150-250	1	STAINLESS STEEL

Item	Description	G1-222	Qty.	Material
A1	HOUSING, BEARING ASSEMBLY (INCLUDES A2 THRU A13)	1330-1000-110	1	CAST IRON
A2	LOCKNUT, SHAFT	1330-1710-230	1	STEEL
A3	LOCKWASHER, SHAFT	1330-1720-230	1	STEEL
A4	ENDCAP, BEARING HOUSING	1330-1200-230	1	STEEL
A5	LIP SEAL, BEARING HOUSING	1330-1900-900	2	BUNA-N
A6	COLLAR, OUTER BEARING SPACER	1330-1300-230	2	STEEL
A7	BEARING	1330-1400-230	2	STEEL
A10	HOUSING, BEARING	1330-1100-110	1	CAST IRON
A11	SET SCREW (3/8"-16 X 3/4"), BEARING HOUSING (NOT SHOWN)	S57U375750WA6L7	2	STEEL
A12	SET SCREW (5/16"-18 X 5/16"), END CAP (NOT SHOWN)	S57U313313WA6L7	2	STEEL
A13	INSERT, BEARING HOUSING (NOT SHOWN)	0020-1790-400	2	NYLON
B1	BRACKET, ASSEMBLY (INCLUDES B2 THRU B8)	1330-2000-130	1	CARBON STEEL/CARBON GRAPHITE
		1330-2010-130	1	CARBON STEEL/BRONZE
B2	BUSHING, BRACKET	1330-2800-300	1	CARBON GRAPHITE
		1330-2800-320	1	BRONZE
B3	FITTING, GREASE (1/8" NPT)	GRSF-013NST-230	1	STEEL
B4	PLUG, PIPE (1/4" NPT)	PLUG-025NSH-230	4	STEEL
B5	PLUG, PIPE (1/4" NPT) (USED WITH LUBRICATED BUSHING)	PLUG-025NSH-230	1	STEEL
	FITTING, GREASE PIN (1/4" NPT) (USED WITH NON-LUBRICATED BUSHING)	GRSF-025NST-230	1	STEEL
B6	SCREWS (5/8"-11 X 1-1/2"), BRACKET	S01C625A50WA2A4	8	STEEL
B7	GASKET, BRACKET	1330-6900-950	1	INTERFACE TS-9003
B8	BRACKET	1330-2100-130	1	CARBON STEEL
C1	CASE, 6" ANSI KIT (INCLUDES B6, B7, C2, F4, F5)	2220-3001-130	1	CARBON STEEL
C2	PLUG, PIPE (3/8" NPT)	PLUG-038NSH-230	2	STEEL
D1	ROTOR, ASSEMBLY (A/B CLEARANCE)	2220-4000-121	1	DUCTILE IRON/STEEL
	ROTOR, ASSEMBLY (C CLEARANCE)	2220-4002-121	1	DUCTILE IRON/STEEL
	ROTOR, ASSEMBLY (D CLEARANCE)	2220-4003-121	1	DUCTILE IRON/STEEL
E1	GEAR, IDLER ASSEMBLY	2220-5000-121	1	DUCTILE IRON/CARBON GRAPHITE
		2220-5010-121	1	DUCTILE IRON/BRONZE
E2	BUSHING, IDLER	2220-5800-300	1	CARBON GRAPHITE
		2220-5800-320	1	BRONZE
F1	HEAD, ASSEMBLY KIT (F2 THRU F7)	2220-6010-130	1	CARBON STEEL/STEEL
F2	PIN, IDLER	2220-6200-231	1	HARDENED STEEL
F3	PLUG, PIPE (1/8" NPT) (USED WITH LUBRICATED BUSHING)	PLUG-013NSH-230	1	STEEL
	FITTING, GREASE PIN (1/8" NPT) (USED WITH NON-LUBRICATED BUSHING)	GRSF-013NST-230	1	STEEL
F4	STUD, HEAD, (5/8"-11 X 2-1/2")	T09C625B50WA2A2	8	STEEL
F5	GASKET, HEAD	1330-6900-950	1	INTERFACE TS-9003
F6	PLUG, PIPE (1/4" NPT)	PLUG-025NSH-230	1	STEEL
F7	NUT, HEAD, (5/8"-11)	N04C625562WA2A2	8	STEEL
G1	VALVE, COVER ASSEMBLY (INCLUDES G2, G13 AND G14)	1330-7000-230	1	STAINLESS STEEL/STEEL
	VALVE, ASSEMBLY-50 PSI (INCLUDES G2 THRU G9, G11 THRU G14)	1330-7001-130	1	CARBON STEEL
	VALVE, ASSEMBLY-80 PSI (INCLUDES G2 THRU G9, G12 THRU G15)	1330-7002-130	1	CARBON STEEL
	VALVE, ASSEMBLY-130 PSI (INCLUDES G2 THRU G9, G11 THRU G15)	1330-7003-130	1	CARBON STEEL
	VALVE, ASSEMBLY-200 PSI (INCLUDES G2 THRU G15)	1330-7004-130	1	CARBON STEEL
G2	VALVE, BODY	1330-7100-130	1	CARBON STEEL
	VALVE, COVER (NOT SHOWN)	1330-7101-250	2	STAINLESS STEEL
G3	VALVE, GASKET BONNET	1330-7910-951	1	KLINGERSIL® C-4401
G4	VALVE, BONNET	1330-7200-130	1	CARBON STEEL
G5	VALVE, GASKET CAP	1330-7920-951	1	KLINGERSIL® C-4401
G6	VALVE, CAP	1330-7300-110	1	CAST IRON
G7	VALVE, ADJUSTMENT SCREW	1330-7700-255	1	STAINLESS STEEL
G8	VALVE, LOCK NUT	1330-7710-255	1	STAINLESS STEEL
G9	VALVE, SPRING GUIDE	1330-7500-250	1	STAINLESS STEEL
G10	VALVE, SPRING LARGE (USED WITH 200 PSI VALVES)	1330-7602-250	1	STAINLESS STEEL
G11	VALVE, SPRING SMALL (USED WITH 50, 130, 200 PSI VALVES)	1330-7600-250	1	STAINLESS STEEL
G12	VALVE, POPPET	1330-7400-110	1	CAST IRON
G13	CAPSCREW (3/8"-16 X 3/4"), VALVE	S01C375750WA2A2	8	STEEL
G14	GASKET, VALVE	1330-7900-950	2	INTERFACE TS-9003
G15	VALVE, SPRING MEDIUM (USED WITH 80, 130, 200 PSI VALVES)	1330-7601-250	1	STAINLESS STEEL
H1	GLAND, PACKING (TYPE 1)	1330-8200-150	1	STAINLESS STEEL
	GLAND, PACKING (TYPE 9)	1330-8201-150	1	STAINLESS STEEL
H2	NUT (5/8"-11), PACKING GLAND	N04C625562CLOA1	2	STAINLESS STEEL
H3	CAPSCREW (5/8"-11), PACKING GLAND	B01C625C00CLOA1	2	STAINLESS STEEL
H4	TYPE 1, COMPONENT SEAL	1330-8000-910	1	VITON
	TYPE 9, COMPONENT SEAL	1330-8001-920	1	PTFE/Ni-RESIST
H5	COLLAR, MECHANICAL SEAL ASSEMBLY	1330-8050-250	1	STAINLESS STEEL
H6	PACKING, KIT (INCLUDES H7)	1330-8100-925K	1	PTFE - GRAPHITE
H7	WASHER, PACKING RETAINING	1330-8150-250	1	STAINLESS STEEL

***Pump runs, but little product flows.***

- Pump speed is too slow.
- Suction piping strainer is too small or obstructed.
- Suction pipe or port is not immersed deep enough within the liquid.
- Piping is improperly installed, permitting air pockets to form in the pump.
- Increased clearances or wear in the pump can cause the pump to deliver an insufficient supply of liquid.
- Air leaks in the suction line.
- Suction losses are too great. The suction lift is too great or the suction line is too small or too long. This can be detected by installing a vacuum gauge directly at the pump suction. The maximum vacuum at the pump suction should never exceed 381 mm-Hg (15 in-Hg). Vaporization caused by higher vacuums will generally result in a reduction of capacity.
- Improper orientation of the head.

***Pump runs but no product flows.***

- Leaks in suction line or port passage. These can be detected by submerging the pressure line from the discharge side of the pump.
- Direction of shaft rotation is incorrect.
- Relief valve setting is too low. Liquid is discharging through the by-pass port.
- The net-positive suction head available (NPSHa) is lower than required for the vapor pressure of the liquid pumped. Recalculate the NPSHa and redesign piping, if necessary.
- Improper orientation of the head.

***Pump operation is erratic or inconsistent.***

- Inconsistent suction conditions.
- Leaking suction lines.
- Pump cavitation due to air or vapor in liquid.

***Pump is excessively noisy.***

- The shaft is worn or bent, causing pump vibration.
- There is an air leak on suction line.
- Cavitation in the pump is occurring.
- The coupling is too close to the pump.
- The coupling is misaligned.

***Pump is leaking.***

- Retighten all fasteners.

**NOTE:** Packed gear pumps are designed to leak slightly to prevent excessive heat build-up. An expected leak rate for packed gear pumps is a few drops per minute; more than this may indicate a problem.

**CAUTION:** When pumping hazardous liquids, a mechanically sealed gear pump is suggested to minimize any potential source of leakage that could result in a hazardous condition.

***Pump is drawing too much power.***

- The pressure is too high.
- Drive shaft and pump are misaligned.
- Pump shaft is bent.
- Pumped liquid has a higher viscosity than originally accounted for.
- Suction or discharge lines are obstructed or restricted.
- Insufficient horsepower.
- Insufficient end clearance, therefore pump is binding.





---

## NOTES

---

Each and every product manufactured by EnviroGear® Pumps is built to meet the highest standards of quality. Every pump is functionally tested to insure integrity of operation.

EnviroGear Pumps warrants that pumps, accessories and parts manufactured or supplied by it to be free from defects in material and workmanship for a period of five (5) years from date of installation or six (6) years from date of manufacture, whichever comes first. Failure due to normal wear, misapplication, or abuse is, of course, excluded from this warranty.

Since the use of EnviroGear Pumps equipment is beyond our control, we cannot guarantee the suitability of any pump or part for a particular application and EnviroGear shall not be liable for any consequential damage or expense arising from the use or misuse of its products on any application. Responsibility is limited solely to replacement or repair of defective EnviroGear products.

All decisions as to the cause of failure are the sole determination of EnviroGear Pumps.

Prior approval must be obtained from EnviroGear for return of any items for warranty consideration and must be accompanied by the appropriate MSDS for the product(s) involved. A Return Goods Tag, obtained from an authorized EnviroGear distributor, must be included with the items which must be shipped freight prepaid.

The foregoing warranty is exclusive and in lieu of all other warranties expressed or implied (whether written or oral) including all implied warranties of merchantability and fitness for any particular purpose. No distributor or other person is authorized to assume any liability or obligation for EnviroGear Pump Company other than expressly provided herein.

**PLEASE PRINT OR TYPE AND FAX TO ENVIROGEAR**

PUMP INFORMATION			
Item # _____		Serial # _____	
Company Where Purchased _____			
YOUR INFORMATION			
Company Name _____			
Industry _____			
Name _____		Title _____	
Street Address _____			
City _____	State _____	Postal Code _____	Country _____
Telephone _____	Fax _____	Email _____	Web Address _____
Number of pumps in facility? _____		Number of EnviroGear pumps? _____	
Types of pumps in facility (check all that apply): <input type="checkbox"/> Diaphragm <input type="checkbox"/> Centrifugal <input type="checkbox"/> Gear <input type="checkbox"/> Submersible <input type="checkbox"/> Lobe			
<input type="checkbox"/> Other _____			
Media being pumped? _____			
How did you hear of Wilden Pump? <input type="checkbox"/> Trade Journal <input type="checkbox"/> Trade Show <input type="checkbox"/> Internet/Email <input type="checkbox"/> Distributor			
<input type="checkbox"/> Other _____			

**ONCE COMPLETE, FAX TO (909) 783-3440**

## Where Innovation Flows



PSG

22069 Van Buren St., Grand Terrace, CA 92313-5607

P: +1 (909) 422-1731 • F: +1 (909) 783-3440

[envirogearpump.com](http://envirogearpump.com)

PSG reserves the right to modify the information and illustrations contained in this document without prior notice. This is a non-contractual document. 07-2016

Authorized PSG Representative:

Copyright ©2016, PSG, A Dover Company